

RoHS

SHANGHAI TOEX TRADING CO., LTD.

Floor 5, Building 6, No. 675, Zhujin Road, Songjiang District, Shanghai, China.

Tel: +86-21-67632060 Fax: +86-21-67632290 E-mail: ssq@toex.cn [Http://www.toex.cn](http://www.toex.cn)



DRYER

GROOMING TABLE

OPERATION TABLE

CAGE

TROLLEY

EXERCISE PEN

ACCESSORIES



Dryers

➤ TD-900X Hercules Dual Motor Dryer	5
TD-9012X Wall Bracket for Dual Motor Dryer	5
TD-901S Stainless Steel Force Dryer	6
TD-900 / 901 / 902 Hosed Dryers	7
TD-9011 Groomer's Third Arm	7
TD-9012 Wall Bracket	7
TD-9013 Dryer Stand	7
TD-904S Supalite Handheld Dryer	8
TD-904S-PRO The 2nd Generation TD-904S	8
TD-9041 Groomer's Third Arm	8
TD-906 Stand Dryer	9
TD-905 Wall-hanging Dryer	10
TD-907 Compartment Dryer	11
TD-908 Noise Terminator - Central Dryer System	12

Grooming Tables

➤ FT-811 / 812 / 813 Folding Grooming Table with S/S Leg	13
FT-8104 Nylon Table Harness	13
FT-8102 Clamp	13
FT-8101 Grooming Arm	14
FT-8103 Table Shelf	14
FT-8120V Oval Top Folding Grooming Table	14
FT-814 / 815 / 816 Folder Table with Powder-plated Leg	15
FT-830 / 830L Round Rotating Table	16
FT-821 Ultra Light Weighted Competition Table	18
FT-820 X-shape Competition Table	18
FT-805C Round Hydraulic Table with Cabinet	19
FT-805 Round Hydraulic Table	20
FT-805REC Rectangular Hydraulic Grooming Table	20
FT-841 Space Saving Folding Table	21
FT-842 Space Saving Folding Table with Cabinet	22
FT-804 / 804L Hydraulic Grooming Table	23
FT-804E / 804LE Electric Lifting Grooming Table	24
FT-806 Super Stable Electric Lifting Table	25
FT-807 Fiber Class Buggy Lifting Table	27
FT-808 Low-Low Electric Lifting Table	28
FT-80401 / 80402 Over-Head Grooming Arm	28
FT-8105 Brand New Ultra-Portable Grooming Arm	28
FT-8106 / 8101 Single Grooming Arm	28
FT-831 Air Lifting Grooming Table	29
FT-832 Super Low Air Lift Grooming Table	30

Operation Tables

➤ FT-826 Multi-Function Operation Table	31
FT-827 Rotational Operation Table	33
FT-828 V-Top Operation Table	34
FT-829 Operation Table with Light	35
FT-824 / 825 / 825W Hydraulic Stainless Steel Operation Table	36
ST-829 Stainless Steel Bi-Level Vet Tub	37
FT-823S / 823M / 823L Exam Table	38
KB-531 Mayo Table	38
KB-520 Equipment Cart	39
KB-521 S/S Cabinet Tools Cart	39

Cages

➤ KA-501 / 502 / 503 Stainless Steel Cages—Kennel Assembly	40
KA-506 / 507 Aluminum Modular Cages	41
KA-505 Professional Modular Cage System	43
KA-504 Dog Crate	45
KA-508 Stainless Steel Professional Modular Cage System	46

Trolleys

➤ KB-511 Aluminum Portable Trolley	47
------------------------------------	----

Exercise Pen

➤ FP-4424 Fabric Playpen	51
Puppy pen	52

Air Purifier

➤ OG-504 Photocatalyst Air Purifier	55
OG-501 Twin Power Ozone Generator	56
OG-502 Ozone Generator	57



next page



Dryers

Grooming Tables

Operation Tables

Cages

Trolleys

Exercise Pen

Air Purifier

Accessories

PR-001 Pet Ramp	58
NG-002 Cordless Nail Grinder	58
NG-003 Series Motor Nail Grinder	59
DS-600 Dog Stacker	60
Professional Grooming Apparel	61
BTF-180 Fiberglass Bathing Tub with Adjustable Stand	62
BTF-180E Fiberglass Bathing Tub with Lifting Base	64
BTS-130 Stainless Steel Bathing Tub with Swing in / out Ramp	65
BTS-85 Stainless Steel Bathing Tub	65
BTS-145 Stainless Steel Hydro Bath	66
Snake Chain	67
Pet Steel Ropes	68

2010 Autumn Launched New Products

Quick Index

TD-9012X Wall Bracket for Dual Motor Dryer	5
TD-904S-PRO The 2nd Generation TD-904S	8
FT-841 Space Saving Folding Table	21
FT-842 Space Saving Folding Table With Cabinet	22
FT-831 Air Lifting Grooming Table	29
FT-832 Super Low Air Lift Grooming Table	30
FT-829 Operation Table with Light	35
FT-823S / 823M / 823L Exam Table	38
KA-508 Stainless Steel Professional Modular Cage System	46
BTS-145 Stainless Steel Hydro Bath	66



Narrow down by professionals

Groomers

TD-900X Hercules Dual Motor Dryer	5
TD-9012X Wall Bracket for Dual Motor Dryer	5
TD-901S Stainless Steel Force Dryer	6
TD-900 / 901 / 902 Hosed Dryers	7
TD-9011 Groomer's Third Arm	7
TD-9012 Wall Bracket	7
TD-9013 Dryer Stand	7
TD-904S Supalite Handheld Dryer	8
TD-904S-PRO The Second Generation TD-904	8
TD-9041 Groomer's Third Arm	8
TD-906 Stand Dryer	9
TD-905 Wall-hanging Dryer	10
TD-907 Compartment Dryer	11
TD-908 Noise Terminator-Central Dryer System	12
FT-811 / 812 / 813 Folding Grooming Table with S/S Leg	13
FT-8104 Nylon Table Harness	13
FT-8102 Clamp	13
FT-8101 Grooming Arm	14
FT-8103 Table Shelf	14
FT-8120V Oval Top Folding Grooming Table	14
FT-814 / 815 / 816 Folder Table with Powder-plated Leg	15
FT-830 / 830L Round Rotating Table	16
FT-821 Ultra Light Weighted Competition Table	18
FT-820 X-shape Competition Table	18
FT-805C Round Hydraulic Table with Cabinet	19
FT-805 Round Hydraulic Table	20
FT-805REC Rectangular Hydraulic Grooming Table	20
FT-841 Space Saving Folding Table	21
FT-842 Space Saving Folding Table with Cabinet	22
FT-804 / 804L Hydraulic Grooming Table	23
FT-804E / 804LE Electric Lifting Grooming Table	24
FT-806 Super Stable Electric Lifting Table	25
FT-807 Fiber Glass Buggy Lifting Table	27
FT-808 Low-Low Electric Lifting Table	28
FT-80401 / 80402 Over-Head Grooming Arm	28
FT-8105 Brand New Ultra-Portable Grooming Arm	28
FT-8106 / 8101 Single Grooming Arm	28
FT-831 Air Lift Grooming Table	29
FT-832 Super Low Air Grooming Table	30
KA-501 / 502 / 503 Stainless Steel Cages—Kennel Assembly	40
KA-505 Professional Modular Cage System	43
KA-506 / 507 Aluminum Modular Cages	41
KA-504 Dog Crate	45
KB-511 Aluminum Portable Trolley	47
OG-503 Photocatalyst Air Purifier	48
OG-501 Twin Power Ozone Generator	56
OG-502 Ozone Generator	57
NG-002 Cordless Nail Grinder	59
NG-003 Series Motor Nail Grinder	59
Professional Grooming Apparel	61
BTF-180 Fiberglass Bathing Tub with Adjustable Stand	62
BTF-180E Fiberglass Bathing Tub with Lifting Base	64
BTS-130 Stainless Steel Bathing Tub with Swing in / out Ramp	65
BTS-85 Stainless Steel Bathing Tub	65
BTS-145 Stainless Steel Hydro Bath	66
Pet Steel Ropes	68

Trainers

KA-501 / 502 / 503 Stainless Steel Cages—Kennel Assembly	40
KA-505 Professional Modular Cage System	43
KA-506 / 507 Aluminum Modular Cages	41
KA-508 Stainless Steel Professional Modular Cage System	46
KA-504 Dog Crate	45
KB-511 Aluminum Portable Trolley	47
FP-4424 Fabric Playpen	51
Puppy pen	52
OG-504 Photocatalyst Air Purifier	55
OG-501 Twin Power Ozone Generator	56
OG-502 Ozone Generator	57
PR-001 Pet Ramp	58
DS-600 Dog Stacker	60
BTS-145 Stainless Steel Hydro Bath	66
Snake Chain	67
Pet Steel Ropes	68

Veterinarians

FT-826 Multi-Function Operation Table	31
FT-827 Rotational Operation Table	33
FT-828 V-Top Operation Table	34
FT-829 Operation Table with Light	35
FT-824 / 825 / 825W Hydraulic Stainless Steel Operation Table	36
ST-829 Stainless Steel Bi-Level Vet Tub	37
FT-823S / 823M / 823L Exam Table	38
KB-531 Mayo Table	38
KB-520 Equipment Cart	39
KB-521 S/S Cabinet Tools Cart	39
KA-501 / 502 / 503 Stainless Steel Cages—Kennel Assembly	40
KA-505 Professional Modular Cage System	43
KA-506 / 507 Aluminum Modular Cages	41
KA-504 Dog Crate	45
KA-508 Stainless Steel Professional Modular Cage System	46
OG-504 Photocatalyst Air Purifier	55
OG-501 Twin Power Ozone Generator	56
OG-502 Ozone Generator	57
BTS-145 Stainless Steel Hydro Bath	66

Breeders

FT-821 Ultra Light Weighted Competition Table	17
FT-820 X-shape Competition Table	18
KA-501 / 502 / 503 Stainless Steel Cages—Kennel Assembly	40
KA-505 Professional Modular Cage System	43
KA-506 / 507 Aluminum Modular Cages	41
KA-504 Dog Crate	45
KA-508 Stainless Steel Professional Modular Cage System	46
KB-511 Aluminum Portable Trolley	47
FP-4424 Fabric Playpen	51
Puppy pen	52
PR-001 Pet Ramp	58
DS-600 Dog Stacker	60
BTS-145 Stainless Steel Hydro Bath	66
Snake Chain	67

TD-900X

HERCULES DUAL MOTOR DRYER

- The most powerful dual motor pet dryer in the world which provides amazing wind speed of over 72m/s (over 15000FPM). • HERCULES double motor dryer is built for durability and longevity, designed to literally blast water off wet coats for faster and more efficient drying.
- The breakthrough technology of the HERCULES dryer presents to you the natural heating, quiet and insulated operation. Hence improve productivity in your business.
- The powerful motor delivers a high volume of regulated warm air to blast water from coats without damaging coats due to overheating.
- A special designed solid state variable speed control device is the answer for various drying needs, air temperature is steady from 35°C - 65°C (95°F-149°F).
- Weight just approximate 13lbs makes it a portable dryer, easy and convenient to be carried and handle anywhere you need.
- Each unit is equipped with 3 meters (10ft) puncture-resistant, tripe reinforced flexible hose. A concentrator and a flare nozzle will handle all breeds and coats.
- Constructed of rugged, durable steel and built to blast, with nonskid tabs on bottom.
- Dual mounted legs, which allow both vertical and horizontal use.
- Filter is washable and easy to replace.



TD-9012X

Wall Bracket For Dual Motor Dryer



ITEM	Single				Packing			
	Net Weight (kg)	Gross Weight (kg)	Dimension (cm)	Volume (cbm)	Box Figure (pcs)	Gross Weight (kg)	Dimension (cm)	Volume (cbm)
TD-900X	6.3	7.5	60×30×23	0.043	3	22.5	63×31×75	0.14



TD-901S

STAINLESS STEEL FORCE DRYER

- A force blower, a finishing dryer and also an air massager, the most versatile dryer in our line.
- Top grade SUS304 stainless steel promises a 10 year service life without any rust.
- This stainless-steel, variable-speed dryer detaches from the workstation stand for use as a portable or floor dryer; the air nozzle swivels 360° for accurate drying.
- Weighing just approximate 12lbs makes it a portable dryer, easy and convenient to be carried and handle anywhere you need; dual mounted legs, which allow both vertical and horizontal use.
- Total steel made workstation stand available, which guarantee reliable stability against tipping; adjustable height from 95-119cm(37.5"-47") with the ease of touching one button; The angle of the hard tube could also be tilted as your need.
- Equipped with a 3 meters puncture-resistant, triple reinforced, flexible hose, three nozzles, one silicone insulated jacket and a SUS304 hard tube.
- Filter is washable and easy to replace.



ITEM	Single				Packing			
	Net Weight (kg)	Gross Weight (kg)	Dimension (cm)	Volume (cbm)	Box Figure (pcs)	Gross Weight (kg)	Dimension (cm)	Volume (cbm)
TD-900S	5	5.3	44×23×30	0.03	4	21.5	64×50×47	0.15



TD-900/901/902

HOSED DRYERS

- The breakthrough technology brings natural heating and quiet, insulated operation to improve productivity in grooming shops.
- Powerful, high velocity dryer delivers a high volume of warm air to blast water from coats without damaging coats with heat.
- Unbreakable "Incoloy" tubular heating element.
- Two-stage filtration and solid state variable speed controls. Two speeds allow you to control the airflow to suit your drying needs.
- Weighing just approximate 5 kg makes it a portable dryer, easy and convenient to be carried and handle anywhere you need.
- The unit has a 3 meters puncture-resistant, triple reinforced, flexible hose with three nozzle options, narrow concentrator, wide concentrator and air flare, to handle all-size pets and all coats.
- Constructed of rugged, durable steel and built to last, with non-skid tabs on bottom.
- Dual mounted legs, which allow both vertical and horizontal use.
- Filter is washable and easy to replace.



ITEM	Single				Packing			Container	
	Net Weight (kg)	Gross Weight (kg)	Dimension (cm)	Volume (cbm)	Box Figure (pcs)	Gross Weight (kg)	Dimension (cm)	Volume (cbm)	20ft 40ft
TD-900 TD-901 TD-902	5	6	44×31×24	0.032	4	25	65×47×51	0.156	680 1450

ITEM	TD-900	TD-901	TD-902
Feature	Variable wind speed No temperature control	Variable wind speed and temperature	Two stage of wind No temperature control
Power	1100w	1600w	1100w
Air Speed	35m/s-45m/s	38m/s-48m/s	35m/s-45m/s
Heat	43°C	43°C-65°C	43°C/ 53°C/ 60°C



TD-9013
Dryer Stand

TD-9012
Wall Bracket

TD-904S

SUPALITE HANDHELD DRYER

- Super Light weighted, only 0.8kg (28oz); No heavy burden on your wrist anymore.
- Small but mighty, providing amazing wind speed at 45m/s, one of the best score in this class.
- Brand new developed Johnson Motor with breakthrough technique brings a 14,000 hours ultra long lifespan and also quiet running.
- 3 stage heating setting and 2 stage speed control, plus genuine tourmaline crystals and ionized concentrator included, ensure a fantastic user experience.
- Advanced tourmaline negative ions seals hair from moisture and uncurl dog hair to go straight as you wish, especially for the curly breeds like poodle, etc.
- One-action cold air button, smart heating control guarantee a shining, silky and smooth finished hair.



TD-9041
GROOMER'S THIRD ARM

- Free both hands for grooming with this convenient attachment.
- Two heavy-duty spring clamps are attached to a flexible 45cm cable to create a helpful "third arm".
- Perfect for positioning handheld dryers.
- Clamps accommodate most size of dryers and feature rubber tips that won't mar tabletops or equipment.
- Gooseneck style cable can be positioned at any angle to hold dryer where you need it to help you grooming more efficiently.

ITEM	Single				Packing			
	Net Weight (kg)	Gross Weight (kg)	Dimension (cm)	Volume (cbm)	Box Figure (pcs)	Gross Weight (kg)	Dimension (cm)	Volume (cbm)
TD-904S	0.8	1.2	25×27×10	0.006	10	14.2	26×29×102	0.07



Removable Wind Concentrator

Two Optional Rear Caps

TD-904S-PRO THE 2ND GENERATION TD-904S SUPALITE HANDHELD DRYER

- Patented air inlet design brings much better noise control to this fantastic dryer.
- Two rear cap options, bigger cap with noise reduction structure offers much quieter operation and small cap offers lighter hand feel.
- 14,000 hours ultra long life motor allows almost 10 years service life averagely (running 4 hours per day).

TD-906

STAND DRYER

- The maximal wind speed of exit is as high as 38m/s. • Temperature range is from 25°C to 75°C. • A heavy duty 1 HP fan air-cooled brushless motor, solid state controls, calrod heating element, and air adjustment. • Variable air and temperature control, suitable for all kinds of breeds. • Provide hands-free fluff drying. • Non-slip sturdy stand, powder coated, with long lasting locking casters;
- Balanced design provides better stability. • Dryer has a lovely orange epoxy finish. • Great technology breakthrough makes its noise much lower. • The filter is easy to clean, with washable foam. • Nozzle rotates 360°, E-Z to be positioned at any angle.



ITEM	Single			Container	
	Net Weight (kg)	Gross Weight (kg)	Dimension (cm)	20ft	40ft
TD-906	12	14	65.7×33.6×26.2 72.5×53×12	0.058 0.046	230 500



TD-905

WALL-HANGING DRYER

- Variable wind and temperature control. • The maximal wind speed of exit is as high as 38m/s. • Temperature range is from 25-75 Celsius Degree. • Brushless motor, Maintenance free - no oiling or greasing of internal parts.
- Only 1800 watt, low energy cost. • Running quiet, lower than 40 db. • Fashion shape designed by Italian master.
- ABS surface of the body, resisting harsh chemicals and strikes. • Outside-inside is two layers, preventing from over-heated. • The nose is made of PPS material, resisting over 260 Celsius Degree high temperature.
- Hanging arm could be lifted and lower for approximately 13 thousand times.



Roof-hanging Bracket Available

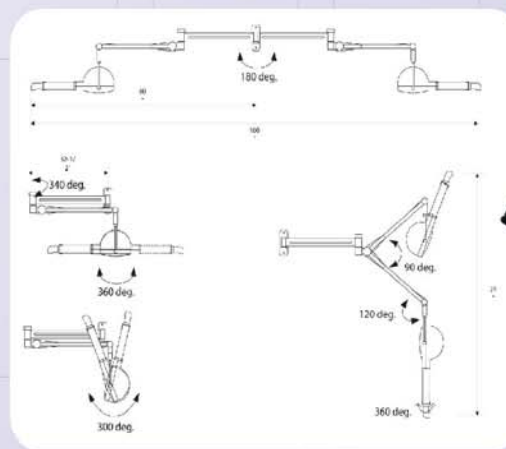

ITEM	Single			Container	
	Net Weight (kg)	Gross Weight (kg)	Dimension (cm)	20ft	40ft
TD-905	12.2	13.8	65.7×33.6×26.2 90.8×21×15.5	0.058 0.030	284 600



TD-907

COMPARTMENT DRYER

- Automatic shut-off timer, could be set from 5-60 minutes.
- Suitable for all breeds of dogs and cats, especially the older and skittish ones.
- Running amazingly quiet, virtually vibration-free, could please even the most sensitive animals.
- High wind pressure, blast water from under coat.
- Solid state control to switch wind and temperature;
- The breakthrough technology of PTC control, keep the temperature safe, steady from 35°C to 50°C.
- Two powerful motors, ultra high volume of 2,700 cubic feet of air per minute----enough to dry up a golden retriever in about 25 minutes.
- Efficient and reasonable air exchange model, make sure the humidity low all the time and enough fresh air for dog.
- Entire stainless steel faceplate and grill, easy to clean and sterilize, last for long time.
- Ozone function, remove the odor away and refresh the air inside; (Attention: Must not use ozone when have dog inside)
- Foolproof operation, hands free from put-in to take-out.
- Dimensions: 126×66×107.5cm(h); inner size 81×65×69cm(h)



Heavy-duty Zinc Die-casting Hinge



Complete Stainless Steel Internal Surface



Flat Face Standing Grid



Fresh Air Intake



ITEM	Single				Container	
	Net Weight (kg)	Gross Weight (kg)	Dimension (cm)	Volume (cbm)	20ft	40ft
TD-907	110	155	126×107.5×66	0.89	24	48

TD-908

NOISE TERMINATOR -- CENTRAL DRYER SYSTEM

THE TERMINATOR OF THE DISEASES CAUSED BY NOISE

If you are a groomer, have you suffered enough of the endless noise from dryers in your working environment?

If you are a pet shop owner, have you ever heard the complaints from your groomers about the irritable noise?

If you are a salesman of professional equipment for pet shops, have you seen the scowl on your potential customer's face for the avoidless noise?

If you are a boss of the equipment distributing company, have you gotten any suggestion or requests about the quiet running dryer?

If you are a doctor, have you ever received any patient who's bearing the pain from high blood pressure, heart disease or tinnitus, caused by noise?



One-Button-Start
Manual Switch on Nozzle

10m Ultra Long
Flexible Hose

Everybody knows noise is not good for people's health, since it may trigger many potential diseases, but what diseases will actually be caused by noise? Here are some researching results from different channels; maybe we can take these as some reference.

Cardiovascular Disease

"In accordance with the noise stress hypothesis chronic stress hormone dysregulations as well as increases of established endogenous risk factors of ischaemic heart diseases have been observed under long-term environmental noise exposure. Therefore, an increased risk of myocardial infarction is to be expected."

"According to the Environmental Expert Council, these studies show a consistent trend towards an increased cardiovascular risk if the daytime immission level exceeds 65 dB(A)."

Source: Noise and Health, Volume 6, Number 22, Jan - Mar 2004, pp. 5-13(9), from Environmental Expert Council of Germany.

High Blood Pressure

"What we found - somewhat unexpectedly - was that the people most exposed to aircraft noise had high blood pressure, says Goran Pershagen, a professor in environmental medical epidemiology at the Institute of Environmental Medicine, Karolinska Institute and continues:

"Even though this is a completely new finding, we have been able to confirm that people who are exposed to loud aircraft noise run the risk of developing high blood pressure. We must do more research about these serious effects to see at what levels they occur."

Source: Gunnell Bergstrom from Stress Research Institute at Stockholm

Heart Disease

"For the new study, researchers examined a database of more than 6,000 employees ages 20 and older who were surveyed about lifestyle, occupation and health. The participants were grouped according to those who endured loud noise at work (meaning it was difficult to talk at a normal volume) for at least three months and those who did not experience loud noise. The study found 21% of workers, mostly men, endured noisy workplaces. They were two to three times more likely to have heart disease compared with workers who did not experience noise."

Source: Shari Roan from Los Angeles Times

Tinnitus

"Causes of ear tinnitus can be defined as follow: Exposure to very loud noise. Internal structure of human ear is very complex and sensitive. Those hearing cords get affected by very harsh, loud noise. The vibrations of the deafening sound hurt the internal structure of ear which causes this disease. Machine operators, factory workers, welders develop ear tinnitus in their mid-forties."

Source: John Robus Mathew from <http://www.earintinnitus.com>

Therefore, we could know noise is the direct cause which triggers many occupational diseases. To avoid these above potential diseases and protect groomer's health; we have spent years of time on researching the noise reduction technology on pet dryers.

Finally, a great breakthrough has been made to realize our dreaming aim.

We name it after Noise Terminator, which is a combination of many advanced technologies, including the Noise Conduction Control in Solid, Noise Absorption, Noise Transmitting in Air, etc. After this epoch-making technology was used on our Central Dryer System, the noise has been reduced to an amazing level at about 65dB, which is a fabulous achievement in the field of pet dryers.

The system can play the role of two powerful dual motor dryers, so that you could blow two dogs at the same time. If necessary, that's even possible to make it more powerful to have four dryers inside with four individual wind outlets.

Two 10m long flexible hoses going along an extendable bar will induce the 72m/s high speed wind from the working center to the top of grooming table. The hoses can be mounted to the ceiling of the room, then the hoses could be protected better and avoid the unnecessary damages. A smart designed spring balancer, with the vertical part of the hose attach to, will lead the hose from ceiling to your working location; when you need to use the dryer, just pull the nozzle down gently, then put it back easily when all the works finished. The most amazing part is, you are able to control the dryer conveniently by pressing the button on the hand holding part, the round nozzle. That's not necessary for you to walk to the working unit to switch it on or off during your busy time, One-Button-Start system brings a much pleasant customer experience to you. You can place the working unit in grooming room, which looks like a cabinet, or put it out of the room to cut the noise 100% off.

Ergonomic, people friendly and easy to use design brings you extraordinary experience on this brand new dryer system, and also brings much healthier and more pleasant working environment.

After all, no matter how much money you earn, health is still priceless, right?

FT-811/812/813

FOLDING GROOMING TABLE WITH S/S LEG

- Non-slip pure rubber matting, pyramidal pattern, scraping resistant and easy to clean.
- Striking desktop, reduce the visual fatigue during long hours working. • Static-free board, easy to clean the eliminate hair and debris. • Waterproof 7-Layer plywood top. • Elastic PVC edging, resists scratches and hauls. • Stainless steel tubular steel leg. • Featured design support brackets, available for heavy weight. • 32mm diameter strong leg and steel reinforced rubber caps make the table ultra high stabilization. • Folds easily for storage.

ITEM	Net Weight	Gross Weight	Dimension(cm)			Volume (cbm)	Container(pcs)	
	(kg)	(kg)	Stand	Fold	Package		20ft	40ft
FT-811	10.7	11.7	75×47×81	83×47×10.5	85×49×11.5	0.048	430	960
FT-812	13.3	14.7	90×60×76.5	90×60×10.5	92×62×11.5	0.066	330	750
FT-813	14.8	16.5	120×60×66	120×60×10.5	122×62×11.5	0.087	240	560



7-COLOR OPTIONS



FT-8104

Nylon Table Harness

- Tight knitted nylon fibers. • Special designed decorated sleeve.



FT-8102

Clamp

- Die pressing, unique designed structure, strong enough to afford fierce pull. • Silver powder-coated finish.

Table Shelf

- Strong enough to keep most your essential grooming tools.
- Black powder-coated finish. • 1" shelves wire grid keeps small items from slipping through. • Each sized grooming table, small, medium and large has the fit shelves.

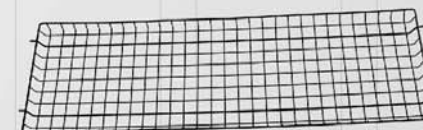

FT-8103



DUAL
Functional
Grooming Arm



FT-8101

Grooming Arm

- Stainless steel. • With holes inside for hanging ropes. • Sectional type, available in two ways. • Adjust at any height, from 60-110cm.

FT-8120V

OVAL TOP FOLDING GROOMING TABLE

- The oval top will help you maximize your work area. • The smaller footprint than normal rectangular tables will allow you to be more closer to pets. • Ease of use for small space shops.

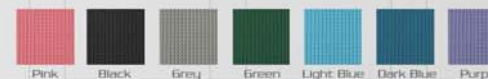

7-COLOR OPTIONS

ITEM	Net Weight	Gross Weight	Dimension(cm)			Volume (cbm)	Container(pcs)	
	(kg)	(kg)	Stand	Fold	Package		20ft	40ft
FT-8120V	11	12.5	90×60×76	90×60×10.5	92×62×11.5	0.068	330	750



FT-814/815/816

FOLDING TABLE WITH POWDER-PLATED LEG

- Classic supporting structure, **super stable**. • Powder painted legs, antirust and nice looking.
- Rubber mat, diamond pattern, scraping resistant and easy to clean. • Many colors to choose, see below swatches. • **Economic price, ideal choice for budget sensitive salons.**



ITEM	Net Weight		Gross Weight		Dimension(cm)			Volume		Container(pcs)	
	(kg)	(kg)	(kg)	(kg)	Stand	Fold	Package	(cbm)	20ft	40ft	
FT-814	12	14	75×47×80	83×47×11.5	85×49×12.5	0.052	420	900			
FT-815	14.4	16	90×60×76.5	90×60×11.5	92×62×12.5	0.071	320	720			
FT-816	16.8	19	120×80×66	120×80×11.5	122×62×12.5	0.095	250	540			

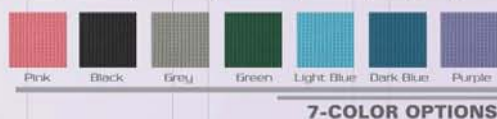

FT-830/830L

ROUND ROTATING TABLE

- Stainless steel ball bearing, rotates completely for easy grooming of toy breeds. • The grooming arm turns smoothly at your touch, and holds still when you let go-allowing you to stay in one position while grooming all sides of dog. • Ergonomic and human oriented design, reducing the groomer's workload.
- Two sizes available.



ITEM	Net Weight		Gross Weight		Dimension(cm)			Volume		Container(pcs)	
	(kg)	(kg)	(kg)	(kg)	Stand	Package	(cbm)	20ft	40ft		
FT-830	5.3	6.3	Ø65×6.5H	72×72×8	0.04	480	1080				
FT-830L	6.8	7.8	Ø70×6.5H	72×72×8	0.04	480	1080				

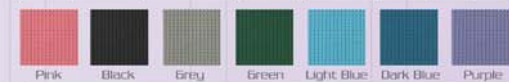



FT-821S (silver)

821P (Purple)

821G (Golden)

821B (Blue)

FT-821

ULTRA LIGHT WEIGHTED COMPETITION TABLE

► • Oxidizing treated colors remains for life long time, many options available, purple, golden, blue, and silver, etc. • A dreamlike colorful competition tables will bring you into a show ring in Wonderland. • Skid-proof, comfortable touch feeling. • Ultra-light weight, only 3.5 -4.8kg (7.7 -10.5lbs), even a little girl could carry this beautiful competition table for her father. • Total Aluminum, long life, most appropriate product for dog show. • Big enough to put most medium breed dogs which need to be trimmed on. • Foolproof folding, only two actions, pulling and carrying, is enough to fold this cute table into a small panel.

ITEM	Net Weight (kg)	Gross Weight (kg)	Dimension(cm)			Volume (cbm)	Container(pcs)	
			Stand	Fold	Package		20ft	40ft
FT-821H	3.7	4.2	60×45×81	89×45×7	94×48×8	0.036	750	1700
FT-821HM	4.8	5.3	75×50×76	97×50×7	99×53×8	0.042	700	1600



FT-820

X-SHAPE COMPETITION TABLE

► • Most appropriate product for dog show, super light weight;
► • Big enough to put most dogs which need to be trimmed on;
• Foolproof folding, only two actions, pulling and carrying, is enough to fold this cute table into a small panel.



ITEM	Net Weight (kg)	Gross Weight (kg)	Dimension(cm)			Volume (cbm)	Container(pcs)	
			Stand	Fold	Package		20ft	40ft
FT-820	6.4	7	60×45×71	82×45×7	84×47×8.5	0.036	750	1700
FT-820H	7.2	8	60×45×81	89×45×7	94×47×8.5	0.038	700	1600
FT-820M	8.4	9	75×50×71	89×50×7	91×52×8.5	0.040	650	1400
FT-820HM	9.3	10	75×50×76	97×50×7	99×52×8.5	0.044	600	1300



FT-805C

ROUND HYDRAULIC TABLE WITH CABINET

► • Very practical design for groomer's daily operation. • Three drawers and one small cabinet is useful when the groomer want to collect and sort handheld dryers, combs, shears, clippers and any other tools. • Also hydraulic controlled, could be lift from 70-84 cm.

ITEM	Net Weight (kg)	Gross Weight (kg)	Dimension(cm)		Volume (cbm)	Container(pcs)	
			Stand	Package		20ft	40ft
FT-805C	35	38.5	Ø70×75-89	71×71×10 50×30×41	0.050 0.068	200	460

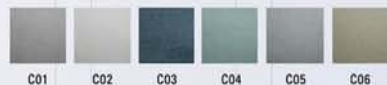

Cabinet colors to choose.



7-COLOR OPTIONS



FT-805

ROUND HYDRAULIC TABLE

► • It swivels 360° for easy access to the entire pet, and brakes in place. • The work surface is round, solid, non-slip, omni-directional ribbed rubber—will not shrink or loosen. • The top quality of hydraulic pump, with warranty for five years. • 7 colors available. • Foot pump operated table adjusts from 70 – 84cm for maximum comfort and grooming efficiency.

ITEM	Net Weight (kg)	Gross Weight (kg)	Dimension(cm)		Volume (cbm)	Container(pcs)	
			Stand	Package		20ft	40ft
FT-805	22.5	25	Ø70×71.5-84	71×71×10 39×39×40	0.050 0.061	220	480

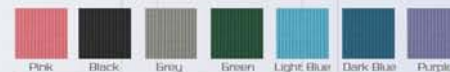

7-COLOR OPTIONS



FT-805REC

RECTANGULAR HYDRAULIC GROOMING TABLE

► • H-Frame base to prevent wobbling. • Featured top that swivels 360 degrees for easy access to entire pet. • Locks in place in any position. • Premium non-slip rubber surface that will not shrink or loosen. • Table adjusts from 28"(70cm) to 33"(84cm). • Outstanding quality italian style hydraulic pump mechanism.

ITEM	Net Weight (kg)	Gross Weight (kg)	Dimension(cm)		Volume (cbm)	Container(pcs)	
			Stand	Package		20ft	40ft
FT-805REC	46.5	49.8	90×60×70-84	91×61×10 71×51×40	0.055 0.144	125	250



7-COLOR OPTIONS



FT-841

SPACE SAVING FOLDING TABLE

- Without moving any objects from the shelf, a simple pull on the wall mounting clip lowers the table to the suitable position and the shelf becomes the foot of the table.
- The center of gravity of the shelf remains perpendicular to ground when moving the table top, since the shaft turns really smoothly.
- A perfect solution for the space sensitive grooming shops, especially the small or mini shops, balances the off season and rush season; you can enlarge your working area and add more platforms in 5 seconds in the rush season and also fold it up to leave more space in off season.
- 100cm×60cm table top with 80cm height when leg fold down.
- 15cm wide shelf board offers great stability when table standing, and also play the role of a tools shelf when table top folded up.
- A special designed stopper ensures the leg won't be knocked down however you kick unconsciously to avoid any potential risk caused by table top falling-off.



Why we need the space saving tables?

To arrange the working area properly is a real challenge for every owner of pet shops, because they always feel there are too few grooming tables when needed in busy season, such as the peak time before every Christmas; and no place to stock the extra tables when not needed at ordinary times. The new launched Space Saving Grooming Table series is the best answer to the above problem, which could balance the rush and off season perfectly. One or two quickly added grooming tables will be a great helper when you need them in a hurry, then the shelf and storage cabinet are still very practical furniture for your grooming room when the table's not needed.



ITEM	Net Weight (kg)	Gross Weight (kg)	Dimension(cm)		Volume (cbm)	Container(pcs)	
			Stand	Package		20ft	40ft
FT-841	19.00	21.00	110×60×80(h)	112×62×24(h)	0.167	174	363

FT-842

SPACE SAVING FOLDING TABLE WITH CABINET

- The Space Saving Table with Cabinet consists of a 100cm long & 60cm wide grooming table top attached to the decorative cabinet.
- The cabinet is not only for the decorative purpose, but also a practical and useful storage cabinet when the table leg folded down.
- The working ergonomic height is 80cm, suitable for most breeds.



ITEM	Net Weight (kg)	Gross Weight (kg)	Dimension(cm)		Volume (cbm)	Container(pcs)	
			Stand	Package		20ft	40ft
FT-842	42.50	44.50	100×60×80(h)	102×72×37(h)	0.272	96	196

FT-804 Series

HYDRAULIC GROOMING TABLE

FT-804/804L

- Rock-solid at any adjusted height, from 51.5-101cm.
- Outstanding quality of hydraulic pump, continuously used for 50,000 times.
- Silver vein surface, antistatic baked epoxy finish for durability.
- Unique "Z" shape design eliminates wobbling and tipping.
- Belgium-made poly-board.
- Elastic PVC edging, resists scratches and hauls.
- All metal-edge, durable and long-lasting.
- Removable desktop and easy to clean.



ITEM	Net Weight	Gross Weight	Dimension(cm)		Volume (cbm)	Container(pcs)	
	(kg)	(kg)	Stand	Package		20ft	40ft
FT-804	46	49.7	96×65×51.5-101	97×67×52	0.338	66	144
FT-804L	48.2	52.7	126×65×51.5-101	127×67×52	0.442	50	110
FT-804E	46	49.7	96×65×65.5-106	97×67×67	0.435	60	127
FT-804LE	49.2	53.7	126×65×65.5-106	127×67×67	0.570	37	78

The Table Top is Removable.



ELECTRIC LIFTING GROOMING TABLE FT-804E/804LE



Electric Pattern Available.



Foot-step

or

Hand pressing

FT-806

SUPER STABLE

ELECTRIC LIFTING TABLE

➤ • The best feature of this table is **S-T-A-B-L-E**. • Four vertical bars holding the table top even lifted to maximum and the center of gravity is still in the middle. • Unbelievable stability against wobbling or tipping, realize the safest electric lifting table in the market. • The minimum height is 36cm (14") when lifted down to bottom, provides much smaller packing size and much lower start point height. • The outer packing size is only 128cmx67cmx38cm (50" x26" x15"), which means the container load will increased by 24%.We could even load 7 layers of this table into a 40'HQ. The height could be adjusted from 36cm to 104cm (14" to 40"), satisfy most daily grooming purpose.

ITEM	Net Weight (kg)	Gross Weight (kg)	Dimension(cm)		Volume (cbm)	Container(pcs)	
			Stand	Package		20ft	40ft
FT-806	50	53.3	126×65×36-104	128×67×38	0.330	71	145



- • Rising Velocity: 13mm/s (off-load) / 11.5mm/s (63kg loading)
- • Descent Velocity: 14.5mm/s (off-load) / 15mm/s (63kg loading)
- Voltage: 110V-120V / 220V-240V • Control Unit: Two Pedal Plates (manual switch available)

• Highlight:

1. More Stable Structure.

Four vertical bars holding the table top even lifted to maximum and the center of gravity is still in the middle.

2. Much Smaller Packing Size.

As the table could be lifted down to 36cm (including the adjustable levels), so the outer packing size is only 128cm×67cm×38cm, which means the container load will increased by 24%. We could even load 7 layers of this table into a 40'HQ.

3. Bigger Regulation Range.

The height could be adjusted from 36cm to 104cm, which will satisfy most daily grooming purpose.



Difunctional Foot Pedal with Flexible Cable

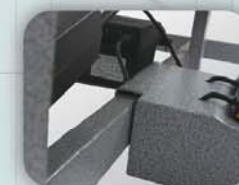

FT-807

FIBERGLASS BUGGY LIFTING TABLE

- Two bright colors to choose, pink and yellow, with featured paws' patterns ornament on the surface to keep skid-proof.
- Patented lifting caster structure, allows the table to keep definitely stable when casters lifted up and outstanding mobility when down to ground.
- Foolproof manual buttons to control lifting up and down; the height can be adjusted from the 54-100cm (21"-40"), to ensure easy step-up access for pet and also right ergonomic height for groomer.
- Practical storage portion design, allows groomers to place brush, spray, blade and scissor easily and conveniently.
- Warm touch feeling surface, provides very special feature as a crash cart; you could put the injured pets onto this buggy from ambulance or owner's car then transport to operation room directly.
- Super long lasting life of the fiberglass material, offers a 50 years use life for this tabletop.
- The loading capacity is 200kg (400lbs), strong enough to hold any breeds; with both single grooming arm and over-head arm available to fix dogs firmly.
- The most functional, convertible and versatile table in our table line.
- Size: 115cm×60cm×54-100cm(45"×23.5"×21"-40")



Hand-pressing Control Unit



Featured Paw Print Skid-proof Ornament Pattern



Patented Foot Pedal Lifting
Omni-directional Wheel System



Storage Portion for
Scissor, Blade And Spray



ITEM	Net Weight (kg)	Gross Weight (kg)	Dimension(cm)		Volume (cbm)	Container(pcs)	
			Stand	Package		20ft	40ft
FT-807	37	39	115×60×54-100	117×62×58	0.42	53	106

FT-808

LOW-LOW ELECTRIC LIFTING TABLE

- The lowest point of this table is only 21cm (8.3"), which is probably the lowest one in the world, provides the easiest step-up access for pets, even the mature and seriously ill ones.
- SKF ball bearing in actuator parts, offers smooth and no-vibration operation, and also long-term reliable running.
- The innovative X-style frame, with powerful and quiet motor, accompanied with both manual and foot pedal, brings a wonderful customer experience.
- Removable tabletop, easy to clean, realizes the possibility to change the color into more personal and fashionable styles.
- Outstanding loading capacity of 150kg (300lbs), is strong enough for most breeds.
- Size: 126cm×65cm×21-100cm (50"×25.5"×8.3-40")



FT-80401/80402 OVER-HEAD GROOMING ARM

ITEM	Net Weight (kg)	Gross Weight (kg)	Dimension(cm)		Volume (cbm)	Container(pcs)	
			Stand	Package		20ft	40ft
FT-808	46	49	125×65×21-101	127×67×24	0.2	130	250



FT-80401



FT-80402

FT-8106 SINGLE GROOMING ARM



FT-8101



FT-8105

BRAND NEW ULTRA-PORTABLE
GROOMING ARM



FT-831

AIR LIFT GROOMING TABLE

➤ The 70cm diameter table top swivels 360° smoothly, with a ball bearing underneath, make it possible to view the dog from any angle easily. Easy-to-Control air lift base offers a big adjustable operation range from 82cm -122cm; you will be able to find the right comfortable height for yourself no matter how tall the dog is. ● Smart designed metal base with anti-scratching white vein powder coating brings reliable stability and durability. ● A set of aluminum clamp and stainless steel bi-purpose grooming arm is equipped. ● 7 colors available for the table top rubber mat.



Easy Press-down Air Switch



Ball Bearing under Table Top

ITEM	Net Weight (kg)	Gross Weight (kg)	Dimension(cm)		Volume (cbm)	Container(pcs)	
			Stand	Package		20ft	40ft
FT-831	21.50	23.50	Ø70×82-102(h)	82×72×42	0.25	110	230

FT-832

SUPER LOW AIR LIFT GROOMING TABLE

➤ The operating top size is 120cm×60cm, which is enough to satisfy any kinds of large and giant breeds. ● The collapsed height reaches unbelievable 15cm, which is almost the same thickness like a normal folding table when folded up. ● The ultra small packing size brings super big container loading quantity as 425 sets (40ft). ● It could also be lifted up to 75cm at the Max height, so you would be able to find the most comfortable and effort-saving position in the range between 15cm to 75cm. ● Using the easiest way to lift the table up by moving the air pump switch by one finger, this brand new air lift table brings unforgettable customer friendly experience.



One Finger Moving Air Switch



Special Caster with Friction Force



ITEM	Net Weight (kg)	Gross Weight (kg)	Dimension(cm)		Volume (cbm)	Container(pcs)	
			Stand	Package		20ft	40ft
FT-832	32.50	34.50	120×60×15-75(h)	122×68×16.5	0.137	200	425

FT-826

MULTI-FUNCTION OPERATION TABLE

• Breakthrough three boards operation system, make it possible for you to enlarge your top size from 19" wide 28.5" wide, which is the only one with this function in the world. (Patented) • Two side panels could adjust from horizontal to near vertical to hold the patient in the desired position during surgery. Overall size of the top: 19"w x 58"l, when two boards on the top. • The side boards could rotate from 0-45 degrees. • E-Z controlled worm bar driving system, provide perfect user experience when you want to lean the table top to a certain angle, from 0 -45 degrees available. • Stainless steel operating table top with leaning function, convenient for all kinds of animal; • Superior quality table is rock-solid at any height, adjustable from 21.5" to 42"; • Each board is 9" wide, designed on the basis of ergonomics, close to the length of the front arm of a vet; • Two blood grooves under the top boards; • Special fixing structure to hold animals with metal chains.



ITEM	Net Weight (kg)	Gross Weight (kg)	Dimension(cm)		Volume (cbm)	Container(pcs)	
			Stand	Package		20ft	40ft
FT-826	60	65	145×57×55-107	147×59×57	0.494	46	102



Sliding Side Panels and Removable Middle Panel Extend Operating Surface



Swiveling Side Panels with Adjustable Angle from 0 -45 Degrees



Smart Worm Bar Driving System Ensure Variable Angle for Work Face

FT-827

ROTATIONAL OPERATION TABLE

- 49"(L)x24"(W) flat top. • Table can be lifted from 50cm to 100cm (20" -40"). • Flat top can revolve 360 degrees, tilt to let the water in pour into the pot. • Directional gas spring with a pull-up control panel secures the top in almost any position, from horizontal to near vertical.
- Imported NSK ball-bearing • Full-automation improves the work more efficient and makes the work easier. • Powerful and durable electric lifting actuator holds 150kg (300lbs) on the surgery top. • Two sliding, quick-release, E-Z control attachments are provided on each side of the attachment rail to offer secured pet restraint. • Raised center permits fluid run-off into a perimeter trough and to a drain outlet.



Quick-release Switch of Air Pump

Waste Liquid Bucket

Zinc Die-casting Ball Bearing Lock

Medical Delicated Caster with Brake



ITEM	Net Weight (kg)	Gross Weight (kg)	Dimension(cm)		Volume (cbm)	Container(pcs)	
			Stand	Package		20ft	40ft
FT-827	60	63	125×60×55-100	126×63×60	0.48	56	100

FT-828

V-TOP OPERATION TABLE

- A two panel system that adjusts from horizontal to near vertical to hold the pets in the desired position during surgery. • Overall size of the top: 20"Wx 55"L. • Powerful and durable electric lifting actuator holds 150kg (300lbs) on the surgery top. • Two sliding, quick-release, E-Z control attachments are provided on each side of the attachment rail to offer secured pet restraint. • A 10cm (4") stainless steel trough permits fluid runoff into a drain outlet. • Table can be lifted from 28"to 67". • Worktop Swivel Angle: 0°~45°



Sliding Drain Outlet



Adjustable Operation Surface Angle



Variable Angle Fixing Handle



Side Panel Fixture Handle

ITEM	Net Weight (kg)	Gross Weight (kg)	Dimension(cm)		Volume (cbm)	Container(pcs)	
			Stand	Package		20ft	40ft
FT-828	70	73	140×50×70-120	143×53×73	0.55	49	87

FT-829

OPERATION TABLE WITH LIGHT

➤ ● A practical working table top size of 120cm×60cm, with a super big adjustable range from 36 -104cm. ● Built-in background light ensures a more relax user experience, especially when considering the easing effect of groomer's eye using effort. ● LED luminous panel provides better diffused gentle lighting, much longer service life and much less electricity consumption. ● A soft transparent silicone mat is equipped, to offer better skid-proof feature. ● It could serve as either an operation table or a grooming table.

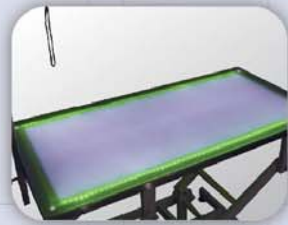

ITEM	Net Weight	Gross Weight	Dimension(cm)		Volume (cbm)	Container(pcs)	
	(kg)	(kg)	Stand	Package (Wooden Box with LIFT Fork Space)		20ft	40ft
FT-829	62.50	78.50	120×60×36-104(h)	124×64×50(h)	0.397	52	112

FT-824/825/825W

HYDRAULIC STAINLESS STEEL OPERATION TABLE

➤ ● Rock-solid table with all stainless steel surface and reinforced construction that eliminates wobbling and tipping. ● Hydraulic foot pedals control the height from 51.5-101cm. ● With a steel basin at one side of the surface. ● 110cm high pole to hang the transfusion bag. ● FT-825W means FT-825 with wheels.

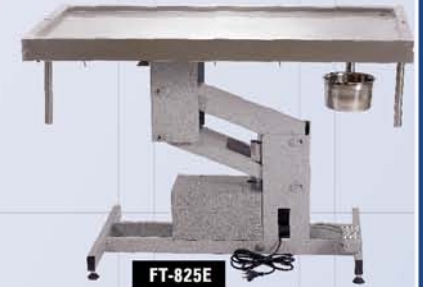

FT-825E

Electric Pattern Available.



OR



Foot-step

Hand pressing

ITEM	Net Weight	Gross Weight	Dimension(cm)		Volume (cbm)	Container(pcs)	
	(kg)	(kg)	Stand	Package		20ft	40ft
FT-824	45	49	90×60×51.5-101	95×65×56	0.346	66	144
FT-825	47.2	51.7	120×60×51.5-101	125×65×56	0.455	50	110
FT-825W	48	52.5	120×60×56.5-106	125×65×56	0.455	44	100
FT-825E	46	49.7	120×60×65.5-106	125×65×70	0.569	48	108

ST-829

STAINLESS STEEL BI-LEVEL VET TUB

• Manufactured with seamless weld construction from SUS304 stainless steel, which could stay at perfect status without any rust. • The tub is sturdily supported by four stainless steel tubular legs which feature fully enclosed gussets and adjustable feet. • The shallow portion of the tub tapers is 4.5" deep before dropping to a 21.5" depth. The inner dimensions measure 20"w x 57"l, and the outer dimensions are 24"w x 61"l. The height to the tub top is 39.5", and to the bottom of the tub is 12". • The drain opening is designed for a 3 1/2" diameter standard drain. All holes for the faucet and drains are pre-drilled. • Stainless steel flat surface grill included.



Flat Surface Floor



Two Panels are Removable



Pre-drill Faucet Holes

ITEM	Net Weight	Gross Weight	Dimension(cm)		Volume (cbm)	Container(pcs)	
	(kg)	(kg)	Stand	Package		20ft	40ft
ST-829	60	71	155×60×100	158×63×102	1.01	26	48

FT-823S/823M/823L

EXAM TABLE

• 1.0mm thick stainless steel surface, with girders underneath. • Strong standing wall around and hooks under the walls, which ensure that animals could be fixed on the table. • With a hole at one side of surface to collect waste residue into a stainless steel basin. • A shelf underneath could keep essential tools ready for you. • 304 good-quality stainless steel board, sturdy, easy to clean up. • 170cm high pole to hang the transfusion bag. • Eight tri-angle reinforce structure stabilize the table.

ITEM	Net Weight	Gross Weight	Dimension(cm)		Volume (cbm)	Container(pcs)	
	(kg)	(kg)	Stand	Package		20ft	40ft
FT-823S	18.0	20.0	75×50×85	77×52×17	0.07	380	820
FT-823M	25.5	27.5	90×55×80	92×57×17	0.09	300	640
FT-823L	33.2	35.5	120×60×80	122×62×17	0.13	210	440

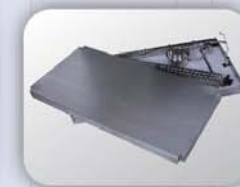

Flat Transportation Packing

KB-531

MAYO TABLE

• Compact size, but large enough for most surgical procedures. • Stainless steel tray measures 17.5"×13.5"×1.5"d (44cm×34cm×4cm) • Easy-slide extension posts allow height adjustments from 31.5" (80cm) to 44" (112cm). • Legs and base are constructed of 1" SUS304 stainless steel tube. • Specialized medical equipment casters, with pressed Aluminum bracket and high quality ball-bearing.

ITEM	Net Weight	Gross Weight	Dimension(cm)		Volume (cbm)	Container(pcs)	
	(kg)	(kg)	Stand	Package		20ft	40ft
KB-531	4	5.2	44×34×80-112	45×35×81	0.128	200	440



KB-520

EQUIPMENT CART

- High class 304 stainless steel. • Smooth flat surface easy to clean.
- Two boards, available for heavy weight. • Strong enough to keep all your operation tools. • Four long lasting casters, two with brake.



ITEM	Net Weight (kg)	Gross Weight (kg)	Dimension(cm)		Volume (cbm)	Container(pcs)	
			Stand	Package		20ft	40ft
KB-520	10	12	64×41×78	66×43×80	0.227	105	220

KB-521

S/S CABINET TOOLS CART

- Stainless steel construction, practical and functional design.
- Two big drawers and 9 stainless steel cups for daily tools storage conveniently. • Smooth surface easy to clean, you could also use a flamegun to eliminate dirts. • Stainless steel tray for tools collection and wastebin hanged on the side of cart. 4" high quality universal casters with lock, easy to control, with long lasting service life.



ITEM	Net Weight (kg)	Gross Weight (kg)	Dimension(cm)		Volume (cbm)	Container(pcs)	
			Stand	Package		20ft	40ft
KB-521	28	29	50×65×90	52×66×93	0.32	85	150

KA-501/502/503

STAINLESS STEEL CAGES—KENNEL ASSEMBLY

- 1.2mm thick high-quality SUS304 stainless steel material, bite proof and vibration proof, very sturdy; • Easy to attach together with strong stainless steel hardware, structure steady; • The horizontal is connected by latches, and vertical by metal sleeves; the sleeves of upper kennels will secure the lower ones, covering the vertical joints; • Four small ones, three medium ones and two large ones will be an assembly, or two small and one large, detailed as follows.

ITEM	Net Weight (kg)	Gross Weight (kg)	Dimension(cm)		Volume (cbm)	Container(pcs)	
			Stand	Package		20ft	40ft
KA-501	20	23	60×72×60	70×76×16	0.085	286	618
KA-502	32.7	36.7	80×72×76	82×77×16	0.100	240	510
KA-503	36.2	40.2	120×72×76	121×77×16	0.149	160	330



Assembly Types:



KA-507 SERIES / KA-506 SERIES

ALUMINUM MODULAR CAGES



KA-507 SERIES

► Obviously stainless steel is an ideal choice for vet cage or salon show cage, but the unsteady price of S/S material has become nightmare of many factories. • Aluminum could play the role of the best substitute of stainless steel, from the rustproof feature, strength, durability and comparatively acceptable price. • At the same time, aluminum has some better features than stainless steel, for example light-weight, easy to process with, etc. • Our brand new aluminum modular cage system is the perfect solver, with uniquely convenient assembling methods. • Every cage, no matter large or small size, could be folded into an 8cm (3") panel, including the space of waste tray and standing grid, which will save much more packing size. • At the same time, you only need to spend 15 seconds to set up one cage, which should be the best record in the assembly cages, saving a lot of time and labor cost for us. • By the way, the mobility is enhanced by handles and casters. • If we fix a set of wheels and handles to the cage, it will be able to be transformed into a trolley easily. • A wonderful option for pet shop owners.



SUPER FUNCTIONAL ASSEMBLY SYSTEM



Featured Coin Driven Screw



Cage Joint Spacer



Cage Side Joint Latch



Clip To Hold Cage Roof



Front Door Stopper



Foldable Handle



Flat Face Grid



KA-506 Aluminum Waste Tray

ITEM	Net Weight (kg)	Gross Weight (kg)	Dimension(cm)		Volume (cbm)	Container(pcs)	
			Stand	Package		20ft	40ft
KA-506S	12.7	14.7	60×72×60	84×64×14	0.08	320	700
KA-506M	17.1	19.1	80×72×76	95×76×16	0.12	210	460
KA-506L	22.5	24.5	120×72×76	156×95×16	0.24	100	230
KA-507S	8.7	10.7	60×72×60	72×64×15	0.07	370	800
KA-507M	11.8	13.8	80×72×76	95×76×16	0.12	210	460
KA-507L	15.2	17.2	120×72×76	156×95×16	0.24	100	230



KA-507 Waste Tray



Tray Stopper

KA-505

PROFESSIONAL MODULAR CAGE SYSTEM



● This professional modular cage system includes everything you need (pans, grates and cage connectors) to build a kennel area unique to your space and needs. ● Specially engineered and designed for safety, strength durability and longevity. ● Unique auto-closing latch system, provide easy and convenient customer experience. ● Brand new Flat-Face standing grill, no need to worry about the interdigital infection of pets when standing long on the round wire made gauge grill. ● Add mobility and versatility with a frame and large cage dividers. ● Cage are made of heavy-duty 20 gauge zinc plated steel with electrostatically powder coated exterior and interior. ● Off-white color matches any decor and does not show dirt. ● Removable doors, dividers, floor grates and pans allow for easy cleaning. ● Mobile platforms are perfect if kennel banks will need to be moved or rearranged. ● They are equipped with large 5" heavy duty zinc plated casters which rotate 360° for easy maneuverability. ● The front wheels lock allowing kennel assembly to remain stationary between moves. ● A brand new group of liquid guide plates are added to ensure no urine or waste water could flow or leak out along the side wall. ● The grid and waste tray are treated by plastic dip coating, which means the tray and grid won't rust at all, unless the surface coating is broken or scratched by sharp objects. ● The service life has been extended a lot.



One-handed Latch



Coin-driven Screws



Denser Wire at Latch Part



Plastic Dip Waste Tray & Grid

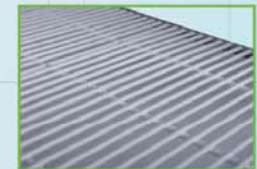

Cage Divider



Liquid Guide Plates & Rubber Seal



ITEM	Net Weight	Gross Weight	Dimension(cm)		Volume (cbm)	Container(pcs)	
	(kg)	(kg)	Stand	Package		20ft	40ft
KA-505S	13.6	15.6	44×50×56	58×52×16	0.048	540	1160
KA-505M	19.5	21.5	55×75×66	68×77×16	0.083	310	670
KA-505L	28.3	30.3	110×80×66	134×82×16	0.177	145	315

KA-504 Series

DOG CRATE

- ▶ Bright Zinc Plating-provides added protection with a show appearance. ● Safe finish won't rub off on dog dry or wet. ● Convenient-top and side door openings. ● Smart folding design, only 2.5"(6.5cm) thick after folding. ● Strong 3.5mm and 2.5mm wires welded up, bent-over prevented.
- One-hand latch operation allows you to open and close door while handling pet.

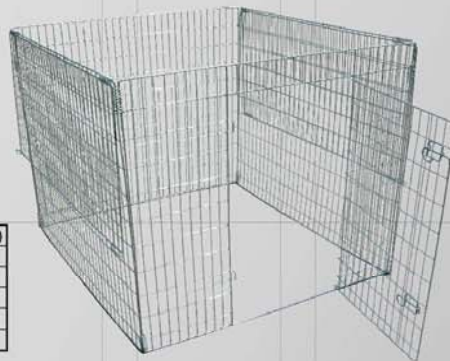
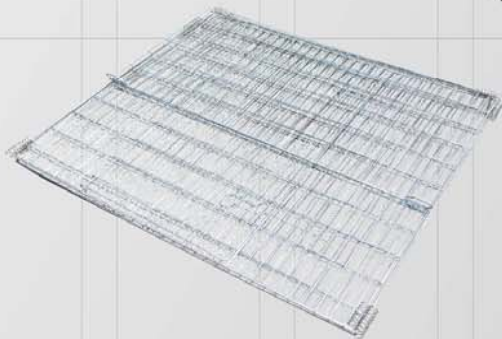
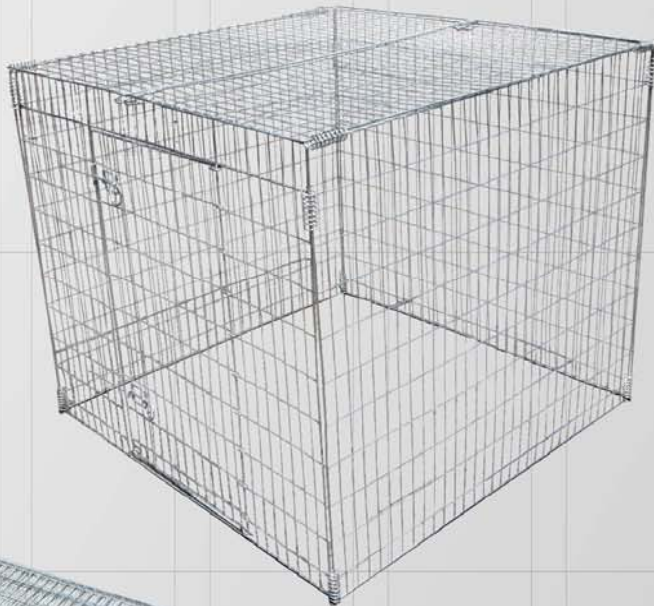

ITEM	Net Weight (kg)	Gross Weight (kg)	Dimension(cm)		Volume (cbm)	Container(pcs)	
			Stand	Package		20ft	40ft
KA-504S	11	13.2	107×107×92	110×95×6.5	0.068	350	790
KA-504M	12.5	14.5	122×122×76	125×79×6.5	0.064	370	840
KA-504L	16.5	18.6	122×122×102	125×105×6.5	0.085	282	630
KA-504XL	18	20	122×122×122	125×125×6.5	0.100	240	540

KA-508

STAINLESS STEEL PROFESSIONAL MODULAR CAGE SYSTEM

- ▶ SUS304 stainless steel material, bite proof and vibration proof, very sturdy. ● Easy to attach together with smart designed strong stainless steel joint connection parts. ● Four small ones, three medium ones and two large ones are an assembly group. ● Totally sealing structure cuts droplet infection off absolutely; the best choice for high class vet clinics and kennels. ● Another customized size system also available, please check the following chart.



Joint Connection Parts



Pull-out Waste Tray



Patented Door Lock



Cross Connection



Double Tray for Large Cage



Double Lock System

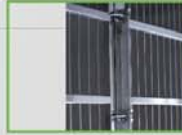

Corner Connection



Flat-face Grid



SUS304 Stainless Steel



Another Customized Size Available
(KA-508-750 & KA-508-1500)

ITEM	Net Weight (kg)	Gross Weight (kg)	Dimension(cm)		Volume (cbm)	Container(pcs)	
			Stand	Package		20ft	40ft
KA-508S	24.5	39.5	60w×72d×60h	64×76×74(h)	0.36	81	162
KA-508M	38.2	58.0	80w×72d×70h	84×76×84(h)	0.54	42	84
KA-508L	43.6	65.0	120w×72d×90h	124×76×104(h)	0.98	26	56
KA-508-750	34.0	54.0	75w×72d×70h	79w×76d×84h	0.50	42	90
KA-508-1500	54.5	77.0	150w×72d×90h	154w×76d×104h	1.22	20	44

※ The package size above includes wooden box and lift fork space of 10cm high.

KB-511

ALUMINUM PORTABLE TROLLEY

Best Dog Show Mate In The World !



BECOME THE STAR IN DOG SHOW PREPARATION ZONE >>>

- The best dog show product on the earth, play the roles of **luggage cart, temporary cage and grooming table**.
- Amazing compact folding size of 92×95×19cm (KB-511NWT for instance), easy to put in car. • No van or car trailer needed any more, a home using vehicle is big enough to carry all your dogs and luggages, with the help of this fantastic powerful trolley.
- Entire Aluminum frame, **super light-weighted** but strong, easy to clean and sterilize, last for long time. • All aluminum parts are anti-rust, durable and heavy-duty for years. • Two optional wheels available, high class nylon with ball bearing for smooth ground and air wheel for mud grassland. • Aluminum board edging, resisting the most rough conditions.
- Double layer rubber matting, scratching resistant. • Four long lasting casters, easy for pushing towards anywhere you need. • Four boards could built six structures, suitable for all your needs. • Folds easily for storage.



4 Compartments



3 Compartments



2 Compartments



Folding View



1 Compartment





Many Helpful Accessory Options
A Specialized Sun-shading Umbrella
For Instance



Wooden Board with Rubber Matting
and Aluminum Edging



Super Omni-direction Air Wheel



Two Sizes and hree Doors Styles for
Different Breeds

Features by Painstaking Efforts



Wavy Skid-proof Surface



Anti-scratching Rubber Mat &
Aluminum Border



Ultra-strong Stainless Steel Hinge



Foldable Handle



Featured Side Wall Latch



Double Reinforced Rivets



Omni-directional Wheel
With Brake



Super Air Wheel



Trolley Detailed Parameter Sheet

Item Number	Dimension (cm)		Volume (cbm)	Weight (kg)		Description
	Stand	Package		Net Weight	Gross Weight	
KB-511NWD	90×65×93(H)	96×20×97(H)	0.19	19.95	21.95	Nylon Wheel, Wooden Board with Aluminum Border, One Door
KB-511NWT				23.95	25.95	Nylon Wheel, Wooden Board with Aluminum Border, Two Door
KB-511NWF				29.63	31.63	Nylon Wheel, Wooden Board with Aluminum Border, Four Door
KB-511NAO				15.26	17.26	Nylon Wheel, Aluminum Board, One Door
KB-511NAT				17.73	19.73	Nylon Wheel, Aluminum Board, Two Door
KB-511NAF				21.31	23.31	Nylon Wheel, Aluminum Board, Four Door
KB-513NWD	80×54×76(H)	81×20×79(H)	0.13	14.55	16.55	Nylon Wheel, Wooden Board with Aluminum Border, One Door
KB-513NWT				17.11	19.11	Nylon Wheel, Wooden Board with Aluminum Border, Two Door
KB-513NAO				11.50	13.50	Nylon Wheel, Aluminum Board, One Door
KB-513NAT				13.16	15.16	Nylon Wheel, Aluminum Board, Two Door
KB-511AWO	90×65×110(H)	103×30×114(H)	0.35	27.56	29.56	Air Wheel, Wooden Board with Aluminum Border, One Door
KB-511AWT				30.41	32.41	Air Wheel, Wooden Board with Aluminum Border, Two Door
KB-511AWF				35.20	37.20	Air Wheel, Wooden Board with Aluminum Border, Four Door
KB-511AAO				23.71	25.71	Air Wheel, Aluminum Board, One Door
KB-511AAT				26.21	28.21	Air Wheel, Aluminum Board, Two Door
KB-511AAF				29.81	31.81	Air Wheel, Aluminum Board, Four Door
KB-513AWO				23.00	25.00	Air Wheel, Wooden Board with Aluminum Border, One Door
KB-513AWT				25.65	27.65	Air Wheel, Wooden Board with Aluminum Border, Two Door
KB-513AAO	20.00	22.00	Air Wheel, Aluminum Board, One Door			
KB-513AAT	21.76	23.76	Air Wheel, Aluminum Board, Two Door			



New Optional Grooming Arm Holder



New Choices of Purple and Blue Colors





Size: 120cm×120cm×60cm (h) 4'×4'×24"
 120cm×120cm×90cm (h) 4'×4'×36"
 180cm×180cm×60cm (h) 6'×6'×24"
 180cm×180cm×90cm (h) 6'×6'×36"
 240cm×240cm×60cm (h) 8'×8'×24"
 240cm×240cm×90cm (h) 8'×8'×36"

FP-4424 SERIES

FABRIC PLAYPEN

► The Super Economy Choice, the most worthy money you spend. • Super heavy duty fabric of Textilene, a composite plastic-yarn with special structure, core body uses high-strength polyester industrial filament, provides perfect anti-scratching, anti-aging and anti-ultraviolet radiation features. • Many different colors to choose, orange, black, gray, blue, green, etc. • Light weighted, easy to carry around. • Specialized fixture stake pole design, easy to anchor the fabric pen securely to dirt or grass. • It should be the best choice for handler and breeder when participating in outdoor shows.

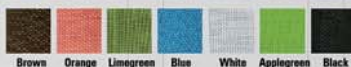

ITEM	Net Weight (kg)	Gross Weight (kg)	Dimension(cm)		Box Figure (pcs)	Volume (cbm)
			Stand	Package		
FP-4424	3.3	4.3	120×120×61	10×10×75	4	0.03
FP-4436	4.7	5.7	120×120×92	10×10×105	4	0.04
FP-6624	4.1	5.1	180×180×61	15×15×75	4	0.07
FP-6636	6.0	7.0	180×180×92	15×15×105	4	0.09
FP-8824	5.0	6.0	240×240×61	18×18×75	4	0.09
FP-8836	7.3	8.3	240×240×92	18×18×105	4	0.13

EXERCISE PEN



► Top-quality pens are perfect for show, travel and home use. • Non-rust aluminum tube, ultra light-weight and fine workmanship, achieve this wonderful exercise pen together. • Durable 25mm×25mm (1") aluminum tubing and narrow spacing adds excellent rigidity and security with no hooks or exposed joints to injure pets. • Specially designed connection structure, easy to set up and fold flat. • A wide selection in this series, including different shapes of square, rectangle, Hexagon and octagon; and different sizes, like 4'×6'×24" (h). • Panels open easily to let pets in or out and fold flat for transport. • With the carefully considered part of a ground anchor on each side underneath, you could use a ground stake to fix the pen to dirt or grassland.





EP-OCT-2824



EP-HEX-2824



ITEM	Net Weight (kg)	Gross Weight (kg)	Stand Dimension(cm)		Package (cm)	Volume (cbm)
			Width of Each Wall	Height		
HEXAGON						
EP-HEX-2824	6.0	7.0	70	60	71×23×62	0.10
EP-HEX-2836	8.4	9.4	70	90	71×23×92	0.15
EP-HEX-3624	7.8	8.8	90	60	91×23×62	0.13
EP-HEX-3636	10.9	11.9	90	90	91×23×92	0.19
OCTAGON						
EP-OCT-2824	8.0	9.0	70	60	71×28×62	0.12
EP-OCT-2836	11.2	12.2	70	90	71×28×92	0.18
EP-OCT-3624	10.4	11.4	90	60	91×28×62	0.16
EP-OCT-3636	14.6	15.6	90	90	91×28×92	0.23



EP-4424



EPH-4448



ITEM	Net Weight (kg)	Gross Weight (kg)	Dimension(cm)		Volume (cbm)
			Stand	Package	
EP-4424	7.2	8.2	120×120×60	124×15×62	0.12
EP-4436	10.1	11.1	120×120×90	124×15×92	0.17
EP-6624	10.8	11.8	180×180×60	94×27×62	0.16
EP-6636	15.1	16.1	180×180×90	94×27×92	0.23
EP-8824	14.4	15.9	240×240×60	124×27×62	0.21
EP-8836	20.2	21.7	240×240×90	124×27×92	0.31
EPH-4448	13.0	15	120×120×120	124×15×122	0.23
EPH-6648	18.2	20.2	180×180×120	94×28×122	0.32
EPH-8848	25.5	27.5	240×240×120	124×28×122	0.42

OG-504

PHOTOCATALYST AIR PURIFIER

► This purifier uses broad spectrum ultraviolet light, reacting with titanium dioxide-based chemical catalyst, in the presence of water, to create hydroxyl radicals and super-oxide ions which oxidize volatile organic compounds, and eliminate microorganisms adsorbed on the catalyst surface. • No sensitive smell, no toxin at all, suitable for any environment and application. • Maintenance free, easy to operate and reliable quality, makes it a very helpful facility on odor removing and bacteria cleaning. • With 3 stage wind speed, it runs so quiet that you cannot even notice it when working normally. • Automatic Count-down timer, easy set up the extended time you want to use.



ITEM	Net Weight	Gross Weight	Dimension(cm)	Volume	Container(pcs)	
	(kg)	(kg)	Stand	(cbm)	20ft	40ft
OG-504	14	15	48×45×58	0.125	216	384

OG-501

TWIN POWER OZONE GENERATOR

► Grooming saloon, pet shop, vet clinic, kennel, pet hotel, pet training school, etc. every place needs this wonderful machinery to remove odor, sterilize and disinfect their environment. • This advanced ozone machine is designed to destroy - not just cover up - pet odors, cleaning chemicals, bacteria, fungus, virus and other indoor air pollution, etc. • Generating high level of ozone, 14g/h, becomes the most efficient machinery in current market. • Purify the air in a 325 square ft room in less than 5 minutes! • 40,000 hours super long lifespan; make sure 50 years usage. • Count-down timer and automatic shut-down function, allows operation without watcher. • Non-stop work allowed, to ensure the stability of ozone generating and always keep it high efficient in use. • No supplementary drugs, no secondary pollution, maintenance free. • 120W only, low power consumption, low carbon product. • Humanized design; easy to use.



ITEM	Net Weight	Gross Weight	Dimension(cm)	Volume	Container(pcs)	
	(kg)	(kg)	Stand	(cbm)	20ft	40ft
OG-501	10.2	11.2	36×29×52	0.05	53	106

OG-502

OZONE GENERATOR

- • Single Fan version, make it more portable for some occasions.
- • Piano baking varnish brings nice looking and fashionable appearance.
- E-Z control, one switch realizes all functions.



ITEM	Net Weight	Gross Weight	Dimension(cm)	Volume	Container(pcs)	
	(kg)	(kg)	Stand	(cbm)	20ft	40ft
OG-502	4.0	5.0	20×20×20	0.008	3200	7000

PR-001



PET RAMP

- • This is the perfect ramp for all pets that need assistance reaching high places. • Made of complete aluminum material, it supports over 300 lbs without bending and only light weighted 20 lbs. • It is also more compact, making it easier to use and store. • It extends from 39" to 72" and anywhere in between. • Use it fully extended for SUV's, pickup trucks, grooming tables, etc. • Shorten the ramp when space is limited or when the upper surface isn't as high. • The unique, wavy walking surface with non-slip tread gives pets a sure footing. • The smart design makes it a stable grooming table when legs unfolded, that's a perfect solution to combine the grooming table and ramp function together. • Dimensions: 39-72" x 20" x 3".
- Both with or without leg patterns available, PR-001W for leg included and PR-001WO for ramp only.



ITEM	Net Weight	Gross Weight	Dimension(cm)		Volume	Container(pcs)	
	(kg)	(kg)	Stand	Package	(cbm)	20ft	40ft
PR-001W	8.5	9.2	180×8×50	95×17×52	0.08	300	700
PR-001WO	6	7.2	180×8×50	95×17×52	0.08	300	700

NG-002

CORDLESS NAIL GRINDER

- Lightweight, ergonomic outer shape, compact design is easy to use anywhere.
- Recharges in just eight hours with removable battery pack.
- Ball bearing shaft drive provides smooth operation.
- Trims nails quickly and smoothly, and is excellent for last minute touch-ups.
- Compact handpiece is easy to maneuver, making it ideal for precision jobs on smaller pets.
- Rotation speed from 5,000 RPM to 25,000RPM adjustable.

Package Includes 6 Grinding Wheel Heads, 2 Batteries and One Charging Set.



NG-003

SERIES MOTOR NAIL GRINDER

- Ultra high motor rotation speed, adjustable from 8,000 RPM to 30,000RPM.
- Safely and efficiently grooms pets' nails for fast, smooth, and accurate results; trimming pets' nails has never been easier than our nail grinder.
- Replacement grinding attachments are also available and sold separately.
- Features quick-change collet for easy changing of attachments and finger grooves with pyramid pattern makes it much more convenient to control.
- Safely and efficiently grooms pets' nails for fast, smooth, and accurate results.
- The kit includes: grinding wheel head 6pcs, with 3pcs of small size and 3pcs of medium size.



Three Options of Grinding Wheel Head

ITEM	Single			Box Figure (pcs)	Packing		
	Net Weight (kg)	Gross Weight (kg)	Dimension (cm)		Gross Weight (kg)	Dimension (cm)	Volume (cbm)
NG-002	0.9	1.3	31×20×8	10	15.0	100×33×22	0.07
NG-003	0.9	1.3	31×20×8	10	15.0	100×33×22	0.07

DS-600 Series

DOG STACKER

- The best choice for breeders!
 - The most efficient training facility to train your dog to behave properly.
 - Light-weight to be portable and easy to travel with.
 - Strong and secure for your dog to feel at ease on.
 - Specialized size for different sized breeds to provides suitable training conditions.
 - A few minutes a day training on the this stacker will turn your fidgety dog into the confident show dog a judge will notice.
 - Plastic absorption processing, water-proof and decent appearance.
 - Non-slip rubber mat adhesived to the top of the stacker provides reliable anti-slippery function.
 - Paws should fit snugly onto the Stacker leg tops. There should be very little space around the foot, nor should toes hang over the edges of the tops. To ensure you order the correct size for your dog, please measure your dog's foot and compare it to the sizes shown of the Show Stacker leg tops.
- Small** Suitable for toy breeds
Stacker top diameter: 60mm (2 3/8") Stacker Height: 130mm (5")
 - Large** Suitable for medium sized and most large sized breeds
Stacker top diameter: 85mm (3 3/8") Stacker Height: 165mm (6 1/2")
 - Giant** Suitable for giant breeds
Stacker top diameter: 115mm (4 5/8") Stacker Height: 165mm (6 1/2")

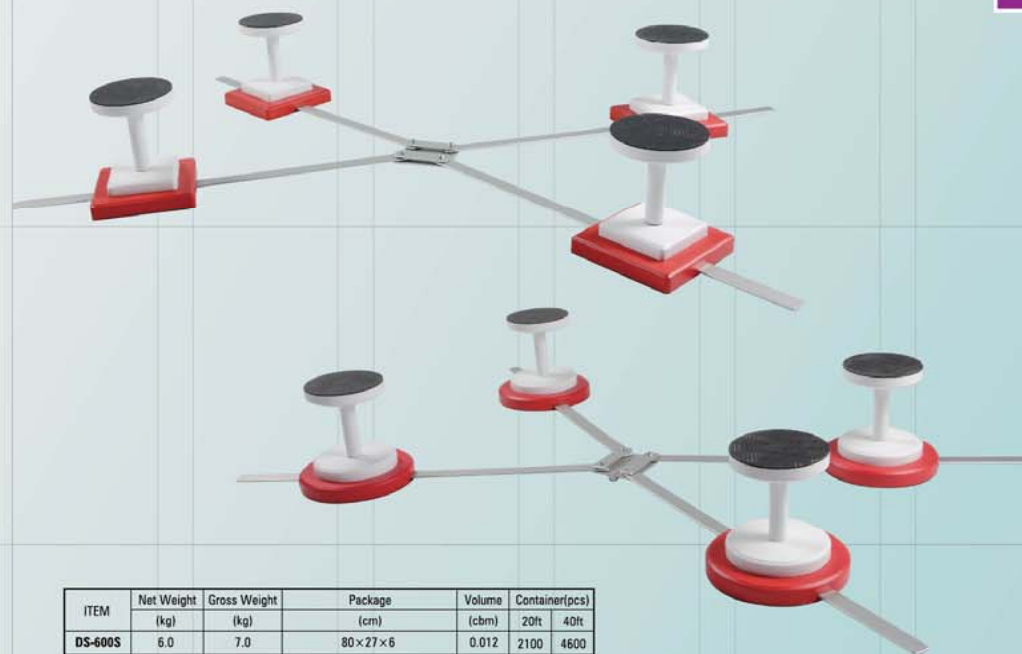

ITEM	Net Weight	Gross Weight	Package	Volume	Container(pcs)	
	(kg)	(kg)	(cm)	(cbm)	20ft	40ft
DS-600S	6.0	7.0	80×27×6	0.012	2100	4600
DS-600M	7.2	8.2	90×29×6	0.015	1700	3700
DS-600L	8.5	9.5	92×31×6	0.017	1500	3200



PROFESSIONAL GROOMING APPAREL

- DUPONT materials, waterproof, dustproof, germproof, antistatic, elastic and ventilate well;
- Four color to choose, pink, silver, blue and purple;
- With and without sleeves patterns;
- Four size, M,L,XL,XXL;
- Print any picture you want on the apparels;
- Adjustable to be tighter or looser to fit body figure.

Item	Description
GA-2111/2112/2113/2114	Medium size With Sleeves Pink/Silver/Blue/Purple
GA-2211/2212/2213/2214	Medium size Without Sleeves Pink/Silver/Blue/Purple
GA-2121/2122/2123/2124	Large Size With Sleeves Pink/Silver/Blue/Purple
GA-2221/2222/2223/2224	Large Size Without Sleeves Pink/Silver/Blue/Purple
GA-2131/2132/2133/2134	XL size With Sleeves Pink/Silver/Blue/Purple
GA-2231/2232/2233/2234	XL size Without Sleeves Pink/Silver/Blue/Purple
GA-2141/2142/2143/2144	XXL Size With Sleeves Pink/Silver/Blue/Purple
GA-2241/2242/2243/2244	XXL Size Without Sleeves Pink/Silver/Blue/Purple

BTF-180

FIBERGLASS BATHING TUB WITH ADJUSTABLE STAND

- Outstanding feature of fiberglass brings 50 years service life.
- Featured paw printing ornament on the bottom of tub plays the role of skid-proof mat.
- Fashionable gray color, matched with gray lifting base, represents for cleaning and reliable service.
- Patented rapid heater built in, heats water up in 3 seconds. Do not need to preheat water anymore, save much more power expense.
- High efficient booster pump, pressurize water to blow into undercoat to help groomer clean the deep dirt easier.
- Blue ray LED lights in the water, renders the water with transparent, purified blue color.
- Stainless steel swing in/out ramp, which could be folded underneath.
- ergonomic stand design, height adjusts from 91cm -106cm!
- Equipped with stainless steel over-head arm and waterproof steel loops.





Fiberglass Foldable Door, Playing The Role of Step Ramp



Ultra-strong Zinc Die Casting Hinge



Ergonomic Adjustable Stand



Spray Head Holder



Blue-ray LED Lights



Shampoo spray Holder



Tools Platform

BTF-180E

FIBERGLASS BATHING TUB WITH ELECTRIC LIFTING BASE



Electric Lifting Base Adjusts from 76cm to 142cm (Which Means the Dog Walk-in Entry Could Get Down to 46cm).



ITEM	Net Weight (kg)	Gross Weight (kg)	Dimension(cm)		Volume (cbm)	Container(pcs)	
			stand	Package		20ft	40ft
BTF-180	108	120	160×82×91-106	180×100×69	1.24	20	45
BTF-180E	84	96	160×82×76-142	180×100×93	1.67	15	33

BTS-130

STAINLESS STEEL BATHING TUB WITH SWING IN/OUT RAMP

> Completely made of Premium Grade 304 stainless steel, heavy duty tub designed for professional use, will not be rusted for at least 10 years under normal usage condition.

 • Pre-drilling holes on each size allows for 4" to 8" faucet hookups.

 • The backsplash features for U shaped hooks for shower heads to hand up to.

 • The access door slides to open while the loading ramp easily swings under tub for storage.

 • High quality NSK ball-bearing on the rotational portion makes sure smooth turning and durable usage.

 • Specially designed steel wire safety catch, make sure the ramp will not affect your daily operation.

 • Includes ramp, tub floor mat and toy breed raised rack with mat.

 • Tubs also come with stainless steel hair strainer, two tub racks with PVC bath mat, to keep pets above suds and dirty water.



BTS-85



ITEM	Net Weight (kg)	Gross Weight (kg)	Dimension(cm)		Volume (cbm)	Container(pcs)	
			stand	Package		20ft	40ft
BTS-130	43	59	130×62×149	136×65×164	1.45	17	38
BTS-85	35	54	84×64×123	88×66×140	0.84	30	66

BTS-145

STAINLESS STEEL HYDRO BATH

> SUS304 top class stainless steel brings the top durability to this hydro-bath, strong and anti-scratching. Skidproof aluminum standing board prevents the potential injury caused by dog sliding. Double filters in water tank, at both water inlet and outlet position, ensure the pump will not be blocked by any hair or dirt. The recirculating water system could save a lot of cost on wasted shampoo and conditioner, since the soapy water still works well after recirculating for times, and also increase the working efficiency significantly. Triple water outlets decide which way the water is coming back and when to release all the waste water out. Two individual pumps and two single circuit controls increase the reliability of the bath a lot, so you can control one recirculating line as you wish. Two side doors allows dogs going in and out of the bath easily. The special designed self-priming pump produces a high volume mix of water and shampoo delivered powerfully enough to penetrate the thickest of coats. The unique Hydro-combing action of the spray head gently massages and stimulates the skin. This is a very effective way of washing your dog but also provides a therapeutic water massage that helps with blood circulation and relief of tired muscles. Other benefits include removal of dead skin cells, embedded flea eggs and any other materials that can be hidden and under normal circumstances prove very difficult to remove. This promotes healthier coats and improved skin conditions.



Double Side Doors



Water Recirculating System



Left Tank Detail



ITEM	Net Weight (kg)	Gross Weight (kg)	Dimension(cm)		Volume (cbm)	Container(pcs)	
			Stand	Package		20ft	40ft
BTS-145	120	160	145×68×130(h)	151×72×145(h)	1.576	11	23



SNAKE CHAIN

ITEM	DESCRIPTION		
	Diameter(mm)	Length(cm)	Color
SN045025GD	2.5	45	golden
SN055025GD	2.5	55	golden
SN060025GD	2.5	65	golden
SN045025SL	2.5	45	silver
SN050025SL	2.5	50	silver
SN055025SL	2.5	55	silver
SN060025SL	2.5	60	silver
SN055030GD	3.0	55	golden
SN060030GD	3.0	60	golden
SN065030GD	3.0	65	golden
SN055030SL	3.0	55	silver
SN060030SL	3.0	60	silver
SN065030SL	3.0	65	silver
SN040035GD	3.5	40	golden
SN045035GD	3.5	45	golden
SN050035GD	3.5	50	golden
SN055035GD	3.5	55	golden
SN060035GD	3.5	60	golden
SN065035GD	3.5	65	golden
SN040035SL	3.5	40	silver
SN045035SL	3.5	45	silver
SN050035SL	3.5	50	silver

ITEM	DESCRIPTION		
	Diameter(mm)	Length(cm)	Color
SN055035SL	3.5	55	silver
SN060035SL	3.5	60	silver
SN065035SL	3.5	65	silver
SN055040GD	4.0	55	golden
SN060040GD	4.0	60	golden
SN065040GD	4.0	65	golden
SN055040SL	4.0	55	silver
SN060040SL	4.0	60	silver
SN065040SL	4.0	65	silver
SN055045GD	4.5	55	golden
SN060045GD	4.5	60	golden
SN065045GD	4.5	65	golden
SN055045SL	4.5	55	silver
SN060045SL	4.5	60	silver
SN065045SL	4.5	65	silver
SN060055GD	5.5	60	golden
SN065055GD	5.5	65	golden
SN070055GD	5.5	70	golden
SN060055SL	5.5	60	silver
SN065055SL	5.5	65	silver
SN070055SL	5.5	70	silver

PET STEEL ROPES



SRS3000310000GR



SRS3000225000BK



SRS5000350000BK



SRS5000235000BK



SRD3030185210BKGR



SRC5000275000BK



SRD3030220260BKRD



SRC5000307000BK

ITEM	DESCRIPTION		PACKING	
	Diameter(mm)	Length	Box Fimure	Gross weight (kg)
SRS3000310000GR	3.0	31"	50pc/Carton	6.10
SRS5000350000BK	5.0	35"	50pc/Carton	9.00
SRD3030185210BKGR	3.0	18.5"/21"	50pc/Carton	6.80
SRD3030220260BKRD	3.0	22"/26"	50pc/Carton	7.00
SRS3000225000BK	3.0	22.5"	50pc/Carton	6.70
SRS5000235000BK	5.0	23.5"	100pc/Carton	7.90
SRC5000275000BK	5.0	27.5"	25pc/Carton	5.80
SRC5000307000BK	5.0	30.7"	25pc/Carton	4.50