



VARVEL[®]
MOTION CONTROL SINCE 1955

technology made in Italy



RS/RT

Since 1955 Varvel has been making speed reducers and variators for light industry applications. Reliable partner in power transmission equipment offers also customized solutions always according to a socially responsible company values. Modularity and flexibility lead Varvel products by a unique kit form, common to all gearbox series. This feature allows distributors an easier job to set up required products in few minutes.

Technology Made in Italy



Technologie Made in Italy

Depuis 1955 Varvel projette et réalise réducteur et variateur mécaniques dédiés à la petite et moyenne industrie. Partner fiable dans la production et la vente d'organes de transmission grâce à un très bon niveau de service, Varvel offre également des solutions personnalisées tout en respectant les valeurs de l'entreprise socialement responsable. Modularité et flexibilité guide la conception des produits Varvel en réalisant des kits communs pour toutes les familles de réducteurs, favorisant ainsi l'activité des distributeurs et revendeurs qui peuvent réaliser en quelques minutes le produit sur demande du client.

Tecnología Made in Italy

Desde 1955 Varvel proyecta y fabrica reductores y variadores de velocidad para aplicaciones de pequeña y mediana potencia. Socio fiable para la producción y venta de órganos de transmisión gracias a un elevado nivel de servicio, ofrece también soluciones personalizadas actuando con el respeto a los valores de la empresa socialmente responsable. Modularidad y flexibilidad guían el diseño de los productos Varvel mediante la realización de kits comunes a toda la familia de reductores, facilitando así la gestión de los distribuidores y revendedores que pueden configurar en pocos minutos el producto solicitado por cada cliente.

Worm Gears

RS - RT



Worm Gears RS-RT

PRODUCT DESCRIPTION

Wormshafts

Z1 profile,
hardened and ground
Alloy steel.

Wormwheels

Bronze Alloy Cast
onto a Cast Iron Hub.

Bearings

Ball or roller types.
Tapered roller bearings
for heavy duty operation.

Housings
of aluminium die cast
or cast iron (sizes 110 up)



Input
NEMA and IEC motor adapters and
Universal Flexible Coupling.
Servo motor adapters:
ask for Servo Gearhead catalogue.

Oil seals
Nitrile Butadiene Rubber - NBR
as standard.
Viton and Silicone on request.

Output
Hollow bore as standard.
Single or Double solid shaft
on request.

Modular attachments
Motor, Helical one stage gearbox,
Output flange, Torque Arm & Torque Limiter

CONTENTS

Product Description	2-4	Dimensions RS	
Symbols & Conversion Factors	5	Worm Gears	28-29
Modular System.....	6-7	Helical/Worm Gears	30-31
Elastic Coupling "G"	8	Double Worm Gears	32-33
Elastic Coupling "G" Selection	9	Alternative Mountings	34-35
NEMA Flanges & Elastic Couplings.....	10	Accessories	36-37
IEC Flanges & Elastic Couplings	11	Dimensions RT	
Electronic Catalogue - 3D-models - 2D-drawings	12	Worm Gears	38-39
Order Designation	13	Helical Worm Gears	40-41
Input Arrangement	14	Double Worm	42-43
Mounting Positions	15-17	Accessories	44-45
Service Factors - Weights & Lubricants - Input Loads. 18		Dimensions XA	
External Loads	19	Helical one-stage gearboxes	46
Ratings RS & RT		General Information	
Worm Gears (3600, 1800, 1200, 900 RPM input) .	20-23	Back-Driving - Gearing Data	47
Helical/Worm Gears (1800 RPM input)	24-26	Direction of Rotation	48
Double Worm Gears (1800 RPM input).....	27	Operation and Maintenance Instructions (abstract)	48

Worm Gears RS-RT

PRODUCT DESCRIPTION

Single worm gear - RS & RT

RS and RT worm gearboxes are specifically designed for universal mounting:

- Sizes: RS (9) / RT (7)
- Reduction ratios (55)
- Max. output torque (27,400 in-lbs)

Aluminium die cast housings and covers up to size 85 and cast iron from size 110.

Torque values of selection tables are output torque values for the specific size and powers referred to 1800 RPM input.

On demand, input Viton oil seals allow trouble-free operation with 2-pole standard AC motors and DC motors, and Silicone oil seals are fitted for low temperature running.

Gearboxes are delivered filled with synthetic long-life oil (Grade ISO VG 320) as standard, ambient temperature +4 /+131 °F (-20/+55 °C), quantities as recommended on page 18 and valid for all mounting positions.

No vent plugs design and factory lubrication-for-life.

Selection table data are intended for service factor SF1.0, i.e. 8-10 running hours per day, uniform load, 15,000 working hours, less than 6 start/stops per hour and room temperature ranging from 60 to 95 °F (15 to 35 °C).

Helical worm gear - RA & TA

RA and TA gearboxes are made of an independent single stage helical gearbox FXA fitted to a standard FRS or FRT gearbox, allowing greater output torques and higher efficiency than the FRS and FRT gearbox with equivalent ratio.

Inputs available in metric only

Both gearboxes are independently lubricated with synthetic long-life oil.

Double worm gear - RS & RT

RS/RS and RT/RT gearboxes are made of two standard gearboxes RS or RT and offer a full selection of high reduction ratios to get even lower output speeds.

Both gearboxes are independently lubricated with synthetic long-life oil.

Output shaft - AS & AD

All gearboxes are manufactured with hollow output shaft as standard. Optionally, a single AS or double AD solid output shaft can be supplied.

An ASC safety shield on the opposite side of a single output shaft AS, is available on demand.

Torque arm - BR & BRV - BT & BTV

Gearboxes are supplied as standard with either side covers for torque arm fitting when the gearbox operates as shaft mounted configuration.

The torque arm, standard BR (for RS) and BT (for RT), or BRV (for RS) and BTV (for RT) with Vulkollan vibration-damping bushing, is made of white galvanized extra thick plate.

Torque limiter - TLE & TLI

The torque limiter and safeguard device - TLI series built-in inside the gearbox and TLE series fitted into the hollow output shaft of a regular gearbox - allows easy torque adjustments, full gearbox safeguard against unexpected overload conditions, simple hand release, and manual operation in case of power supply failure.

The torque limiter device cannot be fitted on RA and TA helical/worm gear and on 2nd stage of double worm gears for full capacity in general: it is possible the fitting with torque limits at some level below to be approved however by our engineers.

The factory preset slipping torque can be adjusted from the maximum pre-set torque down to zero.

Shaft rotation restarts automatically as soon as torque value is lower than the pre-set value.

Dimensions

All dimensions and units of measurement are referred to imperial system, metric in green color where applicable.

Worm Gears RS-RT

PRODUCT DESCRIPTION



	GENERAL SPECIFICATIONS
Range	Sizes: 9 RS + 7 RT 55 reduction ratios 27,400 in-lbs max. output torque
Sizing	According to BS721 15,000 hrs average lifetime with service factor SF1
Housing, Covers	Pressure die cast aluminium AlSi12Cu2Fe till size 85 and cast iron from size 110.
Input - G Type Coupling	Pressure die cast aluminium AlSi12Cu2Fe for sizes 3, 5, 6 and alloyed steel from size 8
Gears	Worms of steel 20MnCr5 CH and tooth profile ZI ground. Wheels of bronze CuSn12 on Cast Iron hub
Shafts & Keys	Steel C43 Shafts h6 - Bores E8 Keys according to DIN6885 B1
Bearings	Ball- or roller-types according to sizes and technical requirements
Oil seals	Type NBR - Nitrile Butadiene Rubber with additional anti-dust lip according to DIN 3760
Lubricant	Synthetic long-life oil Grade ISO VG 320

Worm Gears RS-RT

SYMBOLS - CONVERSION FACTORS

F_r [lb]	Application radial load	
F_{r1} [lb]	Catalogue radial load (input)	
F_{r2} [lb]	Catalogue radial load (output)	
FS	Service factor	$FS = \frac{M_2}{M_{(app)}}$
i	Reduction ratio (real)	
Lub [qt]	Lubricant	
M_2 [in-lb]	Gearbox output torque (k = motor pole #: 2, 4, 6, 8)	$M_2 = 9 * k * P_1 * \eta * i$
$M_{(app)}$ [in-lb]	Application torque	
n_1 [RPM]	Input speed	
n_2 [RPM]	Output speed	
P_1 [HP]	Motor power (k = motor pole #: 2, 4, 6, 8)	$P_1 = \frac{M_2}{9 * k * \eta * i}$
$P_{(kg)}$ [lb]	Weight	
η	Efficiency	

Imperial	CONVERSIONS	Metric
1 lb = 4.45 N 1 lb = 0.454 kg 1 oz = 0.028 kg	Mass & Force	1 N = 0.225 lb 1 kg = 2.205 lb 1 kg = 35.27 oz
HP (60Hz) = kW (50Hz) × 1.341 × 1.2 HP (50 Hz) = kW (50 Hz) × 1.341 HP = in-lb × RPM : (63025 x eff.)	Power	kW (50 Hz) = HP (60 Hz) × 0.745 × 0.833 kW (50 Hz) = HP (50 Hz) × 0.745 kW = Nm × RPM : (9550 × eff.)
1 in-lb = 0.113 Nm 1 ft-lb = 1.355 Nm ft-lb = 108 × k × HP × eff. × ratio in-lb = 9 × k × HP × eff. × ratio = 8000 × k × HP × eff. × o/p speed (where k = motor pole #, i.e. 2, 4, 6, 8)	Torque	1 Nm = 8.851 in-lb 1 Nm = 0.738 ft-lb Nm = 9550 × kW × eff. : RPM
1 qt (US) = 0.946 litre	Volume	1 litre = 1.057 qt (US)

Worm Gears RS-RT

MODULAR SYSTEM

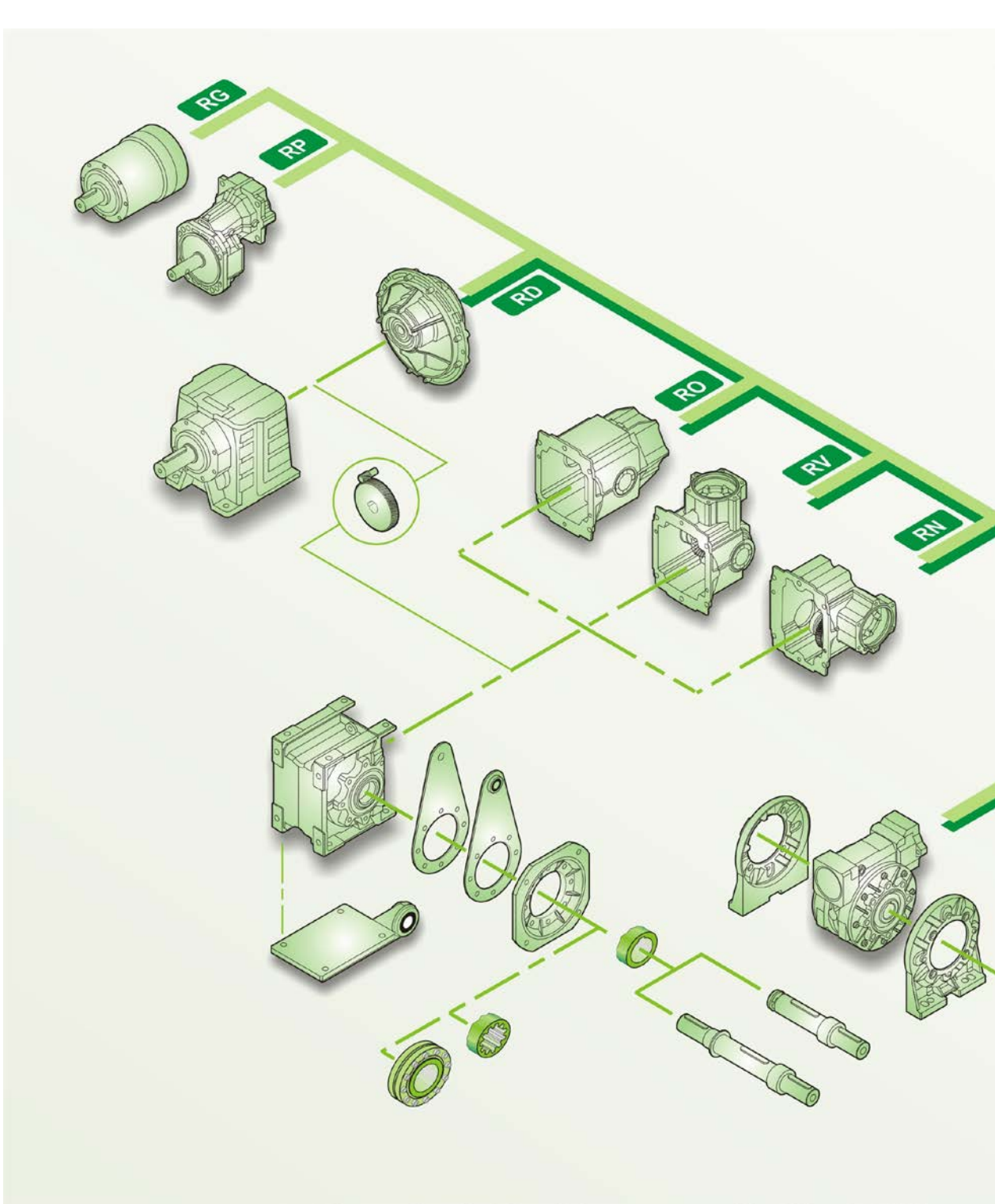

Worm Gears RS-RT

MODULAR SYSTEM

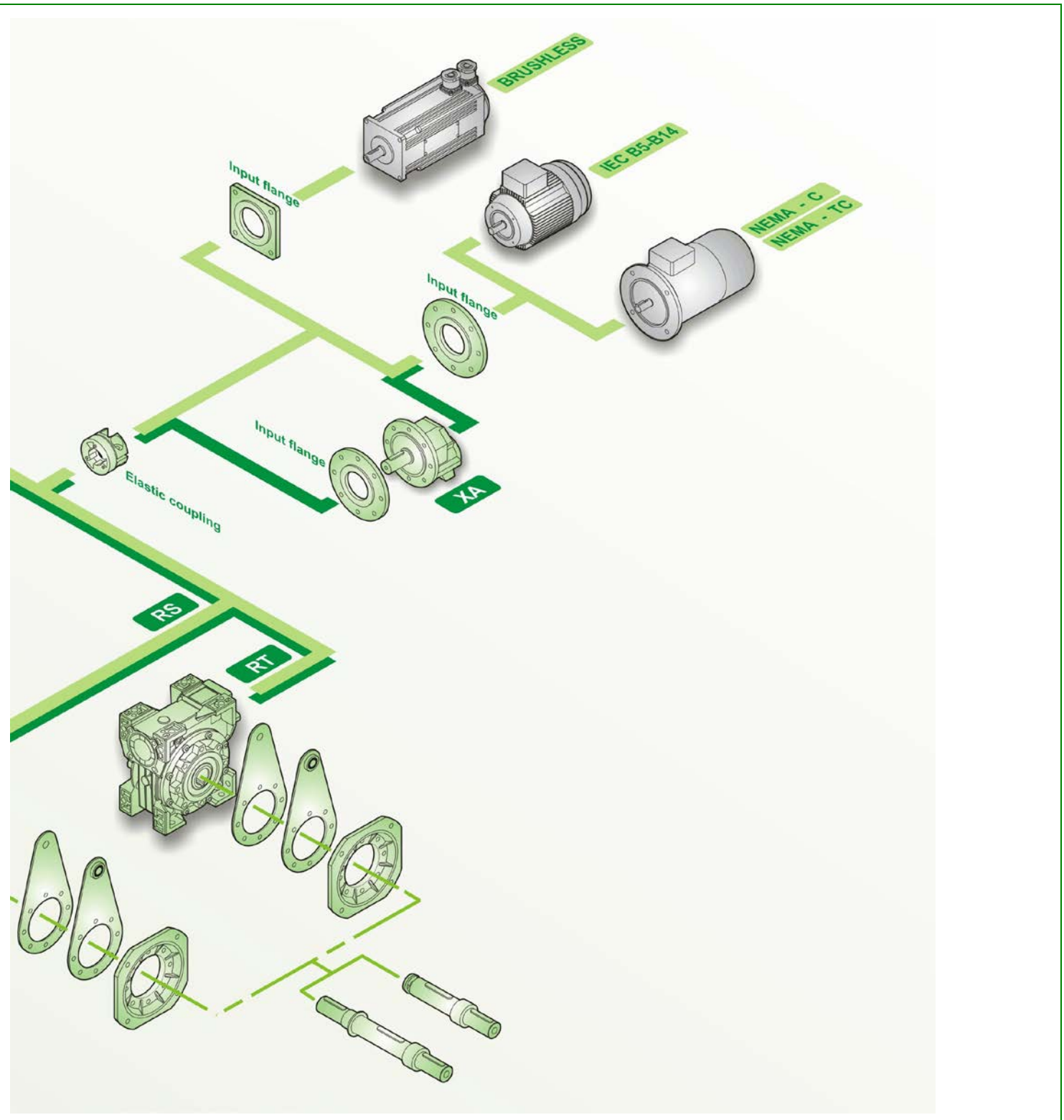

Worm Gears RS-RT

ELASTIC COUPLING "G"

Reducer-side coupling hub

- Material: steel alloy 20MnCr5
- Input shaft built-in
- Two bearing set
- Unchanged casing dimensions

Spider

- External tooth connection
- Material: Thermoplastic Elastomer
- Elastollan® TPU - Polyurethane
- Hytrel® TPE - Polyester
- Hardness
 - TPU 98 Shore A
 - TPE 72 Shore D
- Temperature
 - TPU -4 / +167 °F (-20/+75 °C)
 - TPE -22 / +212 °F (-30/+100°C)

Motor-side coupling hub

- Material:
 - Aluminium die cast (G3, G5, G6)
 - Alloy steel 36SMnPb14 (GS8)
 - Alloy steel C43 on demand (GS3, GS5, GS6)
- Dynamic balancing
- Fitting:
 - Clamp (G3, G5, G6)
 - Key (GS3, GS5, GS6, GS8)
- Bores:
 - NEMA C / TC
 - IEC 72 / N42948

Advantages:

- One gearbox only for each reduction ratio
- Greater flexibility
- Increased stock rotation
- Fretting corrosion elimination between key and keyway
- Zero backlash in gearbox/motor connection
- Allowed angular misalignment 1° max
- High torsional rigidity
- High vibration damping

Input flanges:

- Material:
 - Aluminium up to IEC112 and NEMA 180TC
 - Cast iron from IEC 132 and NEMA 210TC

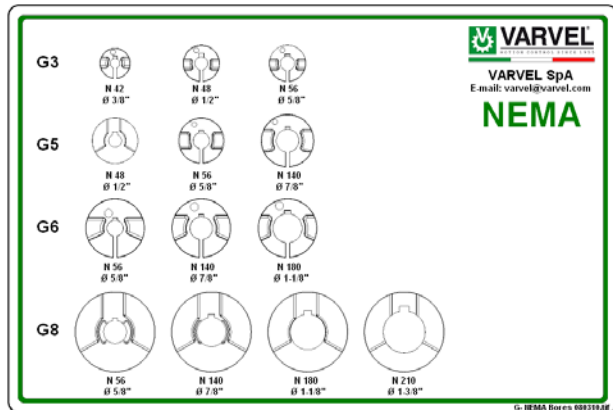
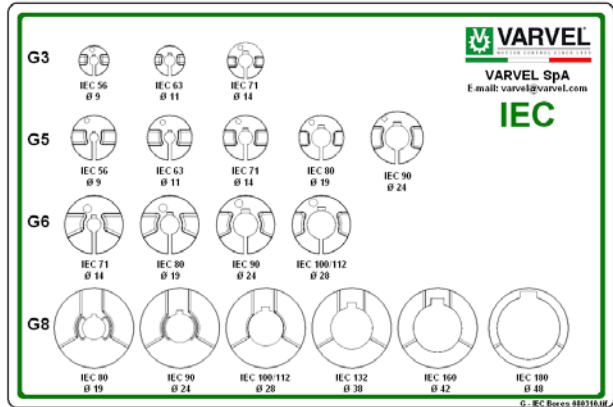

Worm Gears RS-RT

ELASTIC COUPLING "G" SELECTION

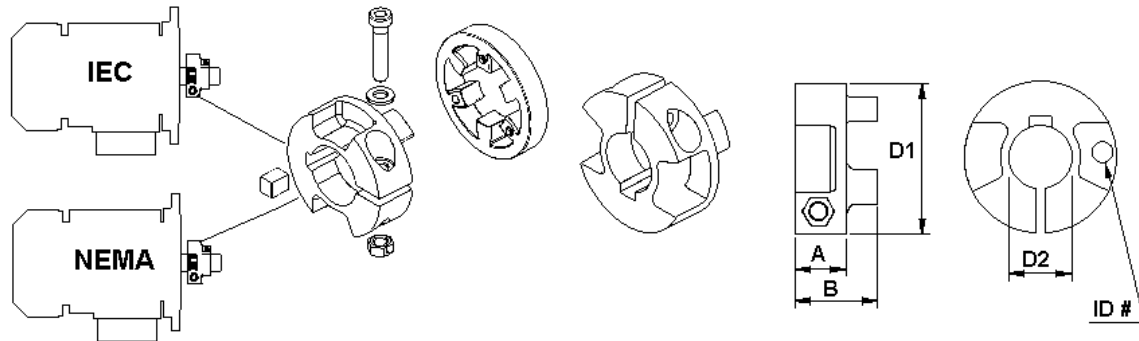

Coupling Size	IEC NEMA	Kit Code	RS - RT	Mt [Nm]	Mt1 [Nm]	Mt2 [Nm]	A [mm]	B [mm]	D1 [mm]	D2 [mm/inch]	ID#
G3	IEC	KG3.009	28-40	4.5 - 6	15	8 - 10	11	19	30	9	309
		KG3.011	28-40	4.5 - 6	15	8 - 10			30	11	311
		KG3.014	40	7 - 8.5	28	18 - 22			36	14	314
	NEMA	KG3.N42	28-40	4.5 - 6	16	8 - 10			30	3/8"	3N42
		KG3.N48	28-40	4.5 - 6	18	10 - 12			36	1/2"	3N48
		KG3.N56	40	7 - 8.5	30	20 - 24			36	5/8"	3N56
G5	IEC	KG5.011	50-60	8.9 - 10	15	8 - 10	14.5	23	45	11	311
		KG5.014	50-60		30	12 - 17			45	14	314
		KG5.019	50-60		40	20 - 25			45	19	319
		KG5.024	60		70	30 - 40			52	24	324
	NEMA	KG5.N56	50-60		45	30 - 35			45	5/8"	5N56
		KG5.N140	60		60	40 - 45			52	7/8"	5N140
G6	IEC	KG6.014	70	15.3 - 18	60	30 - 40	19.5	31.5	58	14	614
		KG6.019	70-85-110		90	50 - 65				19	619
		KG6.024	70-85-110		130	85 - 100				24	624
		KG6.028	70-85-110		180	100 - 120				28	628
	NEMA	KG6.N56	70-85-110		50	---				5/8"	6N56
		KG6.N140	70-85-110		85	---				7/8"	6N140
	KG6.N180	70-85-110	200	---	1-1/8"	6N180					

Mt - Tightening torque
 Mt1 - Transmissible torque with key
 Mt2 - Transmissible torque without key

Worm Gears RS-RT

NEMA FLANGES & ELASTIC COUPLINGS

RS - RT	Flange Size	NEMA	Flange Kit Code	Coupling	
				Type	Kit Code
RS-RT 28	FM 28	42 C 48 C	K530.207.N048 K530.207.N048	G3 ø 3/8" G3 ø 1/2"	KG3.N042 KG3.N048
RS-RT 40	FM 40	42 C 48 C 56 C	K531.227.N048 K531.227.N048 K531.227.N056	G3 ø 3/8" G3 ø 1/2" G3 ø 5/8"	KG3.N042 KG3.N048 KG3.N056
RS-RT 50	FM 50	56 C	K532.227.N056	G5 ø 5/8"	KG5.N056
RS-RT 60	FM 60	56 C 140 TC	K539.227.N056 K539.227.N056	G5 ø 5/8" G5 ø 7/8"	KG5.N056 KG5.N140
RS-RT 70	FM 70	56 C 140 TC 180 TC	K533.227.N056 K533.227.N056 K533.227.N180	G6 ø 5/8" G6 ø 7/8" G6 ø 1-1/8"	KG6.N056 KG6.N140 KG6.N180
RS-RT 85	FM 85	56 C 140 TC 180 TC	K534.227.N056 K534.227.N056 K534.227.N180	G6 ø 5/8" G6 ø 7/8" G6 ø 1-1/8"	KG6.N056 KG6.N140 KG6.N180
RS-RT 110	FM 110	56 C 140 TC 180 TC	K535.227.N056 K535.227.N056 K535.227.N180	G6 ø 5/8" G6 ø 7/8" G6 ø 1-1/8"	KG6.N056 KG6.N140 KG6.N180
RS 130	FM 130	56 C 140 TC 180 TC	K536.227.N056 K536.227.N056 K536.227.N180	# ø 5/8" # ø 7/8" # ø 1-1/8"	--- --- ---
RS 150	FM 130	56 C 140 TC 180 TC 210 TC	K537.227.N056 K537.227.N056 K537.227.N180 K537.227.N180	# ø 5/8" # ø 7/8" # ø 1-1/8" # ø 1-3/8"	--- --- --- ---
XA 63	FM 40	* IEC56 * IEC63	K531.206.120 K531.206.140	# ø9 mm # ø11 mm	--- ---
XA 71	FM 50	* IEC71	K532.206.160	# ø14 mm	---
XA 80	FM 70	* IEC80 * IEC90	K533.206.200 K533.206.200	# ø19 mm # ø24 mm	--- ---
XA 100	FM 85	56 C 140 TC 180 TC	K334.227.N056 K334.227.N056 K334.227.N180	G6 ø 5/8" G6 ø 7/8" G6 ø 1-1/8"	KG6.N056 KG6.N140 KG6.N180

- Key/keyway motor fitting

* - NEMA adapters not available, IEC inputs only

Worm Gears RS-RT

IEC FLANGES & ELASTIC COUPLINGS

RS - RT - XA	Fange	IEC	Kit Code		Coupling	
			Flange B5	Flange B14	Type	Kit Code
RS-RT 28	FM 28	IEC56	K530.206.120	K530.206.080	G3 ø9	KG3.009
		IEC63	K530.206.140	K530.206.090	G3 ø11	KG3.011
RS-RT 40	FM 40	IEC56	K531.206.120	K531.206.080	G3 ø9	KG3.009
		IEC63	K531.206.140	K531.206.090	G3 ø11	KG3.011
		IEC71	K531.206.160	K531.206.105	G3 ø14	KG3.014
RS-RT 50	FM 50	IEC63	K532.206.140	K532.206.090	G5 ø11	KG5.011
		IEC71	K532.206.160	K532.206.105	G5 ø14	KG5.014
		IEC80	K532.206.200	K532.206.120	G5 ø19	KG5.019
RS-RT 60	FM 60	IEC71	K539.206.160	K539.206.105	G5 ø14	KG5.014
		IEC80	K539.206.200	K539.206.120	G5 ø19	KG5.019
		IEC90	K539.206.200	K539.206.140	G5 ø24	KG5.024
RS-RT 70	FM 70	IEC71	K533.206.160	K533.206.105	G6 ø14	KG6.014
		IEC80	K533.206.200	K533.206.120	G6 ø19	KG6.019
		IEC90	K533.206.200	K533.206.140	G6 ø24	KG6.024
		IEC100	K533.206.250	K533.206.160	G6 ø28	KG6.028
RS-RT 85	FM 85	IEC80	K534.206.200	K534.206.120	G6 ø19	KG6.019
		IEC90	K534.206.200	K534.206.140	G6 ø24	KG6.024
		IEC100/112	K534.206.250	K534.206.160	G6 ø28	KG6.028
RS-RT 110	FM 110	IEC90	K535.206.200	---	G6 ø24	KG6.024
		IEC100/112	K535.206.250	K535.206.160	G6 ø28	KG6.028
		IEC132	K535.206.300	K535.206.200	# ø38	---
RS 130	FM 130	IEC100/112	K536.206.250	---	# ø28	---
		IEC 132	K537.206.300	K536.206.200	# ø38	---
RS 150	FM 150	IEC100/112	K536.206.250	K536.206.200	# ø28	---
		IEC 132	K537.206.300	K536.206.250	# ø38	---
		IEC 160	K537.206.350	---	# ø42	---
XA 63	FM 40	IEC56	K531.206.120	K531.206.080	# ø9	---
		IEC63	K531.206.140	K531.206.090	# ø11	---
XA 71	FM 50	IEC71	K532.206.160	K532.206.105	# ø14	---
XA 80	FM 70	IEC80	K533.206.200	K533.206.120	# ø19	---
		IEC90	K533.206.200	K533.206.140	# ø24	---
XA 100	FM 85	IEC80	K534.206.200	K534.206.120	G6 ø19	KG6.019
		IEC90	K534.206.200	K534.206.140	G6 ø24	KG6.024
		IEC100/112	K534.206.250	K534.206.160	G6 ø28	KG6.028

- Key/keyway motor fitting

Worm Gears RS-RT

ELECTRONIC CATALOGUE - 3D-MODELS - 2D-DRAWINGS



Modularity and flexibility have been leading the design of Varvel products since 2000. The gearbox-kit concept was carried out allowing anyone to assemble the unit in a few minutes with standard tooling.

VARSIZE® selection programme, available from our site

www.varvel.com

allows easy sizing selection from the Varvel product range.

2D/3D Drawings

A guided selection allows 2D/3D models to be downloaded for the most popular CAD systems.

Guided selection

This service returns a list of applicable product configurations upon a given sequence of application parameters (power, output torque, rpm, service factor etc.); a PDF data sheet featuring performance data and dimensional drawings is generated for each configuration, as well as the 3D model and 2D drawings.



Worm Gears RS-RT

Example: FRT50/B3 1/20 N56 AC1.0

ORDER DESIGNATION

F	RT	50	/B3	20	N56	AC	1.0					
↓	↓ <div style="border: 1px solid black; padding: 5px; width: fit-content; margin: 0 auto;"> <p>TYPE</p> <p>RT - Universal Mount RS - Original Mount TA - Helical/worm Mount</p> </div>	↓	↓ <div style="border: 1px solid black; padding: 5px; width: fit-content; margin: 0 auto;"> <p>MOUNTING POSITION</p> <p>RS - Pages 15 - 16 RT - Page 17</p> </div>	↓	↓	↓ <div style="border: 1px solid black; padding: 5px; width: fit-content; margin: 0 auto;"> <p>OUTPUT SHAFT</p> <p>AC - Hollow AS - Solid single output AD - Solid dual output</p> </div>	↓					
INPUT TYPE		SIZE			REDUCTION RATIO 1:			MOTOR ADAPTER		SHAFT DIMENSIONS		
		A)	B)	C)	A)	B)	C)	NEMA	IEC	Size	Dia. in	Dia.mm
M - Motorized Unit		28	63/40	28/28	5	32	300	N42	56	28	0.625"	14
F - Motor Flange		40	63/50	28/40	7	44	420	N48	63	40	0.75"	19 (18)
S - Without Motor Flange		50	63/60	28/50	10	63	560	N56	71	50	1.0"	25 (24)
nil - Solid input		60	15	N140	80	60	1.125"	25
		70	100/130	60/130	20	504	8000	N180	90	70	1.25"	28 (30)
		85	100/150	70/150	28	630	10000	N210	100/112	85	1.375"	32 (35)
		110			40				132	110	1.625"	42
		130			56				160	130	1.75"	48
		150			70					150	2.0"	55
					80							
					100							

A) - Single worm gearboxes
 B) - Helical/worm gearboxes (full list of available sizes and reduction ratios at pages 24 to 26)
 C) - Double worm gearboxes (full list of available sizes and reduction ratios at page 27)

OPTIONS

- AS/AD** - Single / double sided solid output shaft
- BR/BRV** - Plain / Vulkollan-bush torque arm
- CS** - Non-standard output bearings
- F/FL** - Additional output flange bolt on body side
- GRM** - Reduced end play
- LNS** - Non-standard lubrication
- TLE/TLI** - Internal / external torque limiter
- VB** - NDE (not drive end) worm shaft extension

Unless otherwise requested, the fitting side of output flanges and optional items is as standard on the right side of the gearbox when seen from input.

Worm Gears RS-RT

INPUT ARRANGEMENTS

FRS/FRT	28	40	50	60	70	85	110	130	150
NEMA42	G3	G3	---	---	---	---	---	---	---
NEMA48	---	G3	---	---	---	---	---	---	---
NEMA56	---	G3	G5	G5	G6	G6	G6	---	---
NEMA140	---	---	---	G5	G6	G6	G6	■	■
NEMA180	---	---	---	---	G6	G6	G6	■	■
NEMA210	---	---	---	---	---	---	---	---	■
IEC56	G3	G3	---	---	---	---	---	---	---
IEC63	G3	G3	G5	---	---	---	---	---	---
IEC71	---	G3	G5	G5	G6	---	---	---	---
IEC80	---	---	G5	G5	G6	G6	---	---	---
IEC90	---	---	---	G5	G6	G6	G6	---	---
IEC100	---	---	---	---	G6	G6	G6	■	■
IEC112	---	---	---	---	---	G6	G6	■	■
IEC132	---	---	---	---	---	---	■	■	■
IEC160	---	---	---	---	---	---	---	---	■
FXA	63	71	80	100					
IEC56	■	---	---	---					
IEC63	■	---	---	---					
IEC71	---	■	---	---					
IEC80	---	---	■	G6					
IEC90	---	---	■	G6					
IEC100	---	---	---	G6					
IEC112	---	---	---	G6					
NEMA56	---	---	---	G6					
NEMA140	---	---	---	G6					
NEMA180	---	---	---	G6					
G 3, 5, 6 - Aluminium die cast flexiblecoupling with inch and metric bores (GS 6, 8) - Steel elastic coupling in progress ■ - IEC and metric quill input (key/keyway fitting)									

Series 'RS'

Worm Gears RS-RT

MOUNTING POSITIONS

Output Configuration (RS , RA , RS / RS)

- Optional configurations (SA, IA, DA, FA, FB, PA,PB): see page 34 for descriptions.

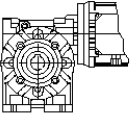
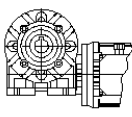
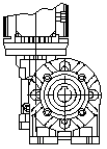
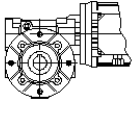
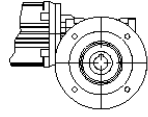
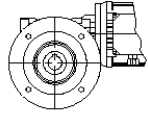
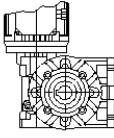
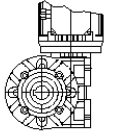
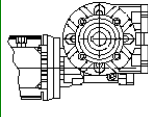
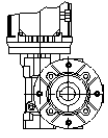
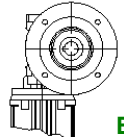
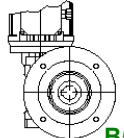
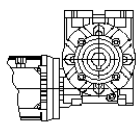
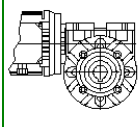
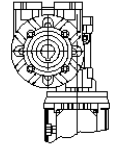
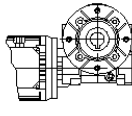
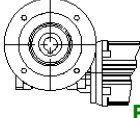
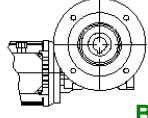
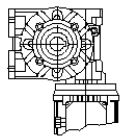
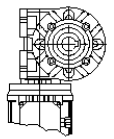
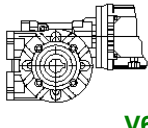
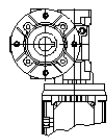
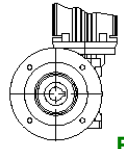
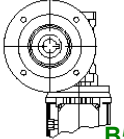
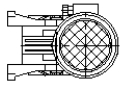
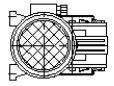
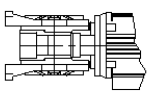
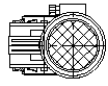
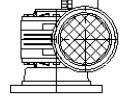
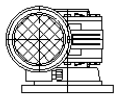
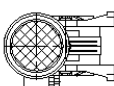
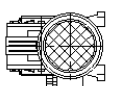
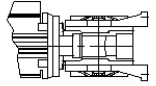
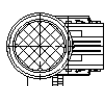
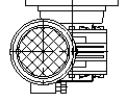
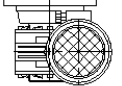
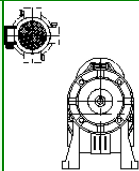
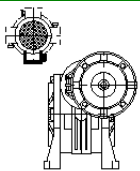
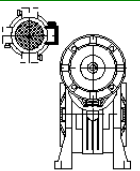
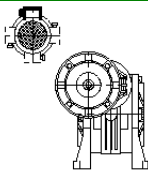
S (SA)	I (IA)	D (DA)	PC - PC	FL (FA,FB) & (PA,PB)	
 B3 (std)	 B3 (std)	 B3 (std)	 B5 (std)	 B5 (std)	 B5i
 V5	 V5	 V5	 B5	 B5a	 B5ai
 B8	 B8	 B8	 B5	 B5b	 B5bi
 V6	 V6	 V6	 B5	 B5c	 B5ci
 B6	 B6	 B6	 V1	 V1	 V1i
 B7	 B7	 B7	 V3	 V3	 V3i
Helical/Worm Input Configuration (RA)	 10 (std)	 11	 12	 13	



Worm Gears RS-RT

Series 'RS'

MOUNTING POSITIONS

Two-Stage Worm Input Configuration (RS / RS)

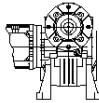
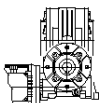
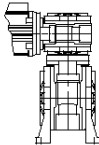
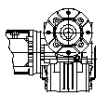
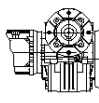
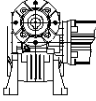
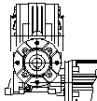
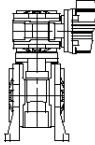
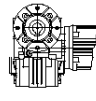
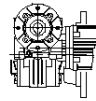
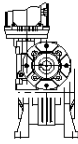
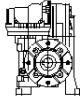
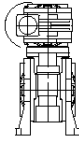
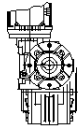
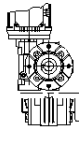
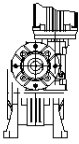
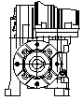
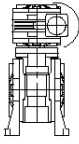
- Optional configurations (SA, IA, DA, FA, FB, PA, PB): see page 34 for descriptions.

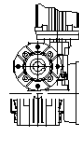
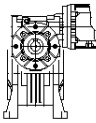
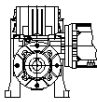
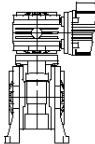
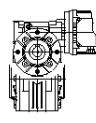
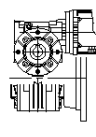
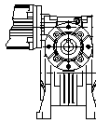
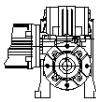
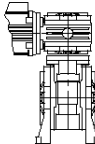
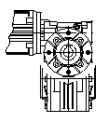
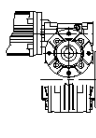
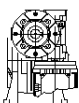
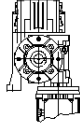
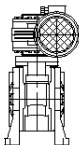
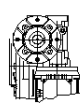
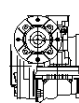
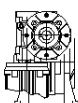
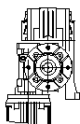
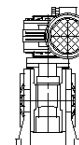
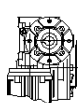
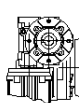
	S (SA)	I (IA)	D (DA)	PC (PA, PB)	FL (FA, FB)
11					
12					
13					
14					
15					
16					
17					
18					

Series 'RT'

Worm Gears RS-RT

MOUNTING POSITIONS

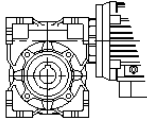
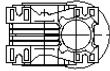
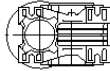
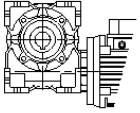
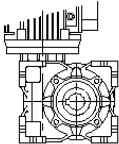
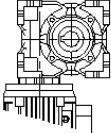
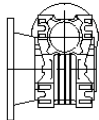
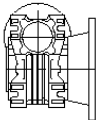
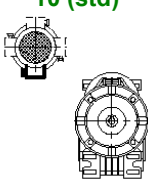
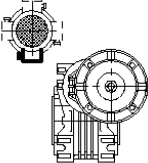
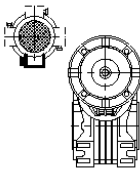
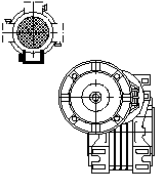
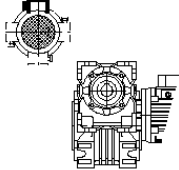
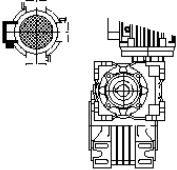
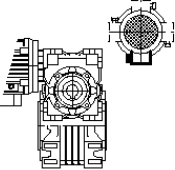
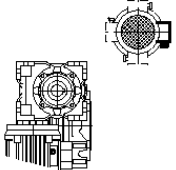
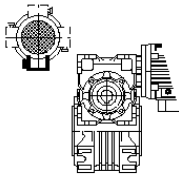
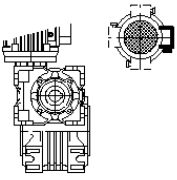
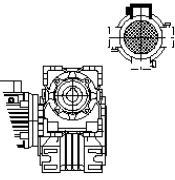
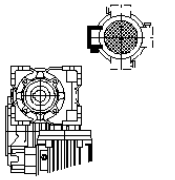
Output Configuration (RT, TA, RT / RT)	<p>B3 (std)</p> 	 <p>B6</p>	 <p>B7</p>	 <p>B8</p>
	 <p>V5</p>	 <p>V6</p>	 <p>F (std)</p>	 <p>Fi</p>
Helical/Worm Input Configuration (TA)	<p>10 (std)</p> 	 <p>11</p>	 <p>12</p>	 <p>13</p>
	 <p>20 (std)</p>	 <p>21</p>	 <p>22</p>	 <p>23</p>
Two-Stage Worm Input Configuration (RT / RT)	 <p>24</p>	 <p>25</p>	 <p>26</p>	 <p>27</p>

Worm Gears RS-RT

SERVICE FACTORS – WEIGHTS & LUBRICANTS – INPUT LOADS

SERVICE FACTORS	Hours	SF ₁			Starts / hour	SF ₂	SF ₁ = Load & Daily Operation factor SF ₂ = Running factor a = Uniform load factor b = Variable load factor c = Shock load factor d = Start/stops per hour factor
		a	b	c		d	
SF = SF ₁ x SF ₂	3 - 4 h	0.8	1.0	1.5	6	1.0	
	8 - 10 h	1.0	1.2	1.8	60	1.2	
	10 - 24 h	1.4	1.6	2.0	120	1.4	

WEIGHTS [lb] & LUBRICANTS [US quarters / litres l]

RS - RT	lb	US qt	l	RA - TA	lb	US qt	l	RS / RS RT / RT	lb
28	2.43	0.03	0.03	63 / 40	8.82	0.04/0.08	0.04/0.08	28 / 28	5.51
40	5.51	0.08	0.08	63 / 50	11.68	0.04/0.14	0.04/0.13	28 / 40	8.60
50	8.38	0.14	0.13	63 / 60	17.64	0.04/0.21	0.04/0.20	28 / 50	11.46
60	14.33	0.21	0.20	71 / 50	14.55	0.06/0.14	0.06/0.13	28 / 60	17.42
70	19.84	0.37	0.35	71 / 60	20.50	0.06/0.21	0.06/0.20	40 / 70	26.46
85	29.76	0.63	0.60	71 / 70	26.01	0.06/0.37	0.06/0.35	40 / 85	36.38
110	85.98	1.59	1.50	71 / 85	35.93	0.06/0.63	0.06/0.60	50 / 110	99.21
* 130	110.23	2.91	2.75	80 / 60	23.15	0.11/0.21	0.10/0.20	*60 / 130	125.66
* 150	176.37	4.65	4.40	80 / 70	28.66	0.11/0.37	0.10/0.35	*70 / 150	198.41
				80 / 85	38.58	0.11/0.63	0.10/0.60		
				80 / 110	94.80	0.11/1.59	0.10/1.50		
				100 / 110	101.41	0.21/1.59	0.20/1.50		
				*100/130	141.09	0.21/2.91	0.20/2.75		
*100/150	207.23	0.21/4.65	0.20/4.40						

(*) - RS sizes only

RS/RS & RT/RT two-stage worm gearbox lubricant: add up lubricant quantity of single-stage gearboxes

INPUT OVERHUNG LOAD (OHL) - R₁ [lb] INPUT AXIAL LOAD - A₁ = 0.2 x R₁ [lb]

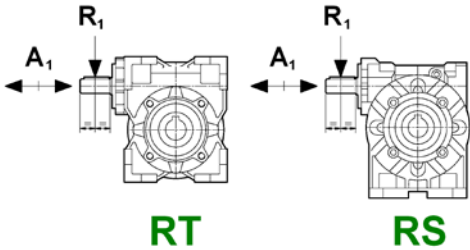
RPM	3300	1800	1100	900	600	350	
RS-RT 28	11	15	17	19	22	26	
RS-RT 40	24	32	35	37	39	43	
RS-RT 50	32	43	48	54	61	65	
RS-RT 60	50	65	71	76	80	87	
RS-RT 70	56	76	87	95	102	108	
RS-RT 85	74	97	112	125	134	151	
RS-RT 110	123	162	173	184	199	216	
RS 130	151	216	227	238	249	260	
RS 150	195	260	270	281	303	324	

Worm Gears RS-RT

EXTERNAL LOADS

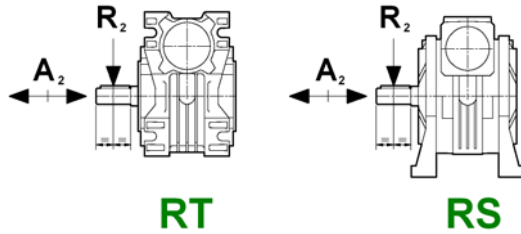

STANDARD BEARINGS

- Output Overhung Load (OHL) R_2 [lb]
 - Output Axial Load $A_2 = 0.2 \times R_2$ [lb]

Ratio i = RPM	5 336	7 240	10 168	15 112	20 84	28 60	40 42	49 35	56 30	70 24	80 22	100 17	Bearing Type
RS-RT28	---	97	108	119	130	134	151	162	173	195	205	216	16005
RS-RT40	216	216	238	260	292	324	346	368	389	411	433	497	16006
RS-RT50	314	270	314	368	411	433	497	519	562	606	627	692	16008
RS-RT60	487	519	541	627	714	779	843	930	995	1081	1146	1211	①
RS-RT70	562	584	627	779	843	908	973	1125	1189	1276	1363	1449	②
RS-RT85	714	714	800	952	1016	1168	1189	1363	1427	1536	1622	1795	③
RS-RT110	---	843	898	1125	1168	1276	1233	1622	1687	1730	1903	2119	④
RS130	---	1081	1265	1330	1406	1427	1687	1903	2055	2098	2271	2487	6015
RS150	---	1406	1665	1795	1903	1946	2379	2595	2703	2812	3028	3244	6216

① - RS: 6008 / RT: 6208 ② - RS: 6009 / RT: 6209 ③ - RS: 6010 / RT: 6210 ④ - RS: 6012 / RT: 6212

HEAVY DUTY BEARINGS

- Output Overhung Load (OHL) R_2 [lb]
 - Output Axial Load $A_2 = 0.2 \times R_2$ [lb]

Ratio i = RPM	5 336	7 240	10 168	15 112	20 84	28 60	40 42	49 35	56 30	70 24	80 22	100 17	Bearing Type
RS-RT28	---	141	162	177	195	201	227	242	260	281	281	281	6005
RS-RT40	303	324	335	357	411	454	487	519	541	562	562	562	32006
RS-RT50	433	378	433	519	562	649	735	779	843	908	908	908	32008
RS-RT60	627	649	692	800	908	1038	1103	1233	1319	1427	1427	1427	30208
RS-RT70	725	714	800	973	1116	1211	1319	1492	1579	1709	1709	1709	⑤
RS-RT85	887	908	995	1189	1363	1557	1579	1817	1882	2033	2033	2033	⑥
RS-RT110	---	1081	1168	1449	1622	1730	2011	2271	2401	2401	2401	2401	⑦
RS130	---	1514	1709	1860	2098	2141	2530	2790	3071	3136	3136	3136	32015
RS150	---	1946	2336	2509	2855	2920	3568	3893	4044	4217	4217	4217	30216

⑤ - RS:32009 / RT: 30209 ⑥ - RS: 32010 / RT: 30210 ⑦ - RS:32012 / RT: 30212

Worm Gears RS-RT

3600 RPM input

RATINGS

2 poles - SF 1.0

3600 RPM	Ratio	5	7	10	15	20	28	40	49	56	70	80	100
	output RPM	720	514	360	240	180	129	90	73	64	51	45	36
RS - RT 28 1.10" CD	HP	---	1.06	0.82	0.59	0.42	0.39	0.27	0.22	0.20	0.15	0.13	0.07
	in-lb	---	115	124	124	115	133	124	115	106	97	89	62
	eff.	---	0.86	0.83	0.79	0.77	0.69	0.64	0.61	0.54	0.49	0.49	0.46
RS - RT 40 1.57" CD	HP	3.52	2.51	2.01	1.37	0.94	0.82	0.60	0.50	0.44	0.35	0.32	0.25
	in-lb	283	274	301	301	266	301	283	274	266	257	248	230
	eff.	0.89	0.87	0.85	0.81	0.78	0.72	0.66	0.62	0.6	0.57	0.54	0.51
RS - RT 50 1.97" CD	HP	1.49	1.46	1.42	1.36	1.31	1.21	1.11	1.04	1.01	0.96	0.91	0.85
	in-lb	513	549	522	540	460	584	522	496	469	407	434	354
	eff.	0.9	0.88	0.86	0.82	0.8	0.75	0.69	0.66	0.64	0.58	0.58	0.52
RS - RT 60 2.36" CD	HP	9.72	7.38	5.87	4.36	3.18	2.68	1.84	1.21	1.22	1.01	0.87	0.57
	in-lb	797	823	920	974	956	1027	929	752	814	814	752	602
	eff.	0.9	0.88	0.87	0.84	0.82	0.76	0.73	0.71	0.66	0.64	0.6	0.58
RS - RT 70 2.76" CD	HP	13.58	9.55	7.21	5.36	4.02	3.69	2.51	2.01	1.68	1.34	1.16	0.91
	in-lb	1115	1080	1151	1230	1204	1425	1372	1257	1151	1062	1018	947
	eff.	0.91	0.89	0.88	0.85	0.83	0.78	0.74	0.7	0.68	0.63	0.61	0.58
RS - RT 85 3.35" CD	HP	21.79	16.09	12.57	8.88	7.21	5.20	4.02	3.35	2.85	2.18	1.84	1.56
	in-lb	1788	1814	1991	2071	2097	2080	2213	2142	2027	1859	1770	1682
	eff.	0.91	0.89	0.88	0.86	0.8	0.8	0.76	0.72	0.71	0.67	0.64	0.6
RS - RT 110 4.33" CD	HP	---	29.33	24.81	17.94	14.42	11.73	8.38	7.54	6.03	5.20	5.03	3.52
	in-lb	---	3319	3938	4160	4337	4691	4602	4823	4337	4646	4779	3983
	eff.	---	0.9	0.88	0.86	0.84	0.79	0.76	0.73	0.71	0.7	0.67	0.62
RS 130 5.12" CD	HP	---	44.09	36.21	26.48	20.45	15.76	12.91	10.06	8.88	6.54	5.53	4.02
	in-lb	---	5000	5797	6239	6328	6328	7213	6549	6903	5930	5487	4956
	eff.	---	0.9	0.89	0.87	0.86	0.8	0.78	0.74	0.77	0.72	0.68	0.68
RS 150 5.91" CD	HP	---	62.02	49.62	38.22	28.66	22.80	17.94	14.25	11.06	9.22	8.21	6.03
	in-lb	---	7036	7965	8983	8894	9425	10355	9647	8585	8408	8098	7478
	eff.	---	0.9	0.89	0.87	0.86	0.82	0.8	0.77	0.77	0.72	0.68	0.68

1800 RPM input

Worm Gears RS-RT

4 poles - SF 1.0

RATINGS

1800 RPM	Ratio	5	7	10	15	20	28	40	49	56	70	80	100
	output RPM	360	257	180	120	90	64	45	37	32	26	23	18
RS - RT 28 1.10" CD	HP	---	0.75	0.55	0.39	0.27	0.27	0.17	0.15	0.13	0.10	0.08	0.05
	in-lb	---	159	159	159	142	177	150	150	133	106	106	71
	eff.	---	0.84	0.81	0.77	0.74	0.66	0.62	0.57	0.51	0.45	0.45	0.43
RS - RT 40 1.57" CD	HP	1.87	1.84	1.36	0.92	0.64	0.62	0.42	0.35	0.30	0.23	0.20	0.15
	in-lb	398	398	407	389	345	425	372	363	336	319	283	257
	eff.	0.87	0.85	0.83	0.78	0.75	0.68	0.61	0.58	0.56	0.52	0.50	0.46
RS - RT 50 1.97" CD	HP	4.53	3.02	2.18	1.56	1.06	1.06	0.69	0.62	0.52	0.42	0.34	0.22
	in-lb	717	664	664	655	575	752	637	673	628	558	513	381
	eff.	0.88	0.86	0.84	0.78	0.76	0.71	0.64	0.62	0.60	0.53	0.52	0.47
RS - RT 60 2.36" CD	HP	6.87	4.69	3.86	2.68	2.01	1.68	1.26	1.04	0.91	0.77	0.62	0.42
	in-lb	1106	1000	1177	1151	1080	1230	1195	1133	1089	1080	938	735
	eff.	0.89	0.86	0.84	0.81	0.77	0.71	0.66	0.62	0.60	0.55	0.53	0.49
RS - RT 70 2.76" CD	HP	9.55	6.71	5.20	3.69	3.02	2.51	2.01	1.41	1.24	0.97	0.84	0.62
	in-lb	1558	1469	1593	1664	1717	1912	2106	1673	1593	1443	1363	1151
	eff.	0.89	0.88	0.86	0.83	0.81	0.75	0.71	0.67	0.64	0.59	0.56	0.52
RS - RT 85 3.35" CD	HP	15.25	10.39	7.71	5.70	4.86	3.69	2.68	2.35	2.01	1.61	1.44	0.92
	in-lb	2469	2292	2372	2558	2850	2823	2876	2797	2699	2567	2478	1859
	eff.	0.90	0.88	0.86	0.83	0.82	0.76	0.72	0.67	0.68	0.63	0.60	0.56
RS - RT 110 4.33" CD	HP	---	20.95	15.09	10.90	9.55	7.38	5.87	4.53	3.69	3.35	2.51	1.84
	in-lb	---	4646	4708	4956	5726	5682	6115	5584	5266	5620	4646	4151
	eff.	---	0.88	0.87	0.84	0.83	0.76	0.73	0.71	0.70	0.67	0.66	0.61
RS 130 5.12" CD	HP	---	31.85	25.14	18.44	14.25	12.57	9.22	6.54	6.20	4.53	4.02	3.02
	in-lb	---	7142	7877	8496	8629	9735	10089	8408	8894	7655	7169	6638
	eff.	---	0.89	0.87	0.85	0.84	0.77	0.76	0.72	0.71	0.67	0.63	0.61
RS 150 5.91" CD	HP	---	41.74	35.20	26.82	20.95	15.92	13.41	9.89	8.55	6.37	5.53	4.36
	in-lb	---	9381	11151	12479	12656	12700	14868	12744	12567	10886	10355	9912
	eff.	---	0.89	0.88	0.86	0.84	0.79	0.77	0.73	0.73	0.68	0.65	0.63

Worm Gears RS-RT

1200 RPM input

RATINGS

6 poles - SF 1.0

1200 RPM	Ratio	5	7	10	15	20	28	40	49	56	70	80	100
	output RPM	240	171	120	80	60	43	30	24	21	17	15	12
RS - RT 28 1.10" CD	HP	---	0.60	0.40	0.30	0.22	0.20	0.13	0.12	0.10	0.07	0.05	0.03
	in-lb	---	195	177	186	168	195	177	168	142	115	97	71
	eff.	---	0.82	0.78	0.72	0.7	0.61	0.56	0.52	0.45	0.43	0.4	0.37
RS - RT 40 1.57" CD	HP	2.01	1.41	1.07	0.74	0.50	0.47	0.32	0.27	0.23	0.20	0.17	0.13
	in-lb	478	460	478	460	398	460	407	381	363	354	345	319
	eff.	0.86	0.83	0.8	0.74	0.7	0.63	0.56	0.52	0.49	0.46	0.44	0.42
RS - RT 50 1.97" CD	HP	3.52	2.51	1.84	1.26	0.87	0.85	0.59	0.47	0.42	0.32	0.28	0.20
	in-lb	850	841	841	805	699	876	752	717	708	593	593	487
	eff.	0.86	0.85	0.81	0.76	0.72	0.65	0.58	0.56	0.54	0.47	0.46	0.42
RS - RT 60 2.36" CD	HP	5.36	4.02	3.18	2.35	1.68	1.46	0.94	0.72	0.67	0.54	0.47	0.32
	in-lb	1328	1328	1443	1469	1425	1549	1345	1195	1151	1106	1018	832
	eff.	0.87	0.85	0.83	0.75	0.76	0.68	0.64	0.61	0.55	0.53	0.48	0.47
RS - RT 70 2.76" CD	HP	7.54	5.36	4.02	2.85	2.18	2.01	1.46	1.07	0.89	0.70	0.64	0.50
	in-lb	1876	1788	1867	1929	1832	2142	2124	1814	1655	1505	1416	1301
	eff.	0.88	0.86	0.83	0.79	0.77	0.7	0.654	0.62	0.59	0.54	0.5	0.46
RS - RT 85 3.35" CD	HP	12.07	8.38	6.54	5.03	3.52	3.02	2.51	1.68	1.39	1.22	1.07	0.85
	in-lb	2991	2832	3098	3345	3142	3301	3629	3098	2938	2655	2567	2301
	eff.	0.88	0.86	0.84	0.8	0.78	0.71	0.66	0.672	0.671	0.55	0.53	0.48
RS - RT 110 4.33" CD	HP	---	16.43	13.41	9.55	7.38	6.20	4.53	3.86	3.18	2.85	2.51	1.58
	in-lb	---	5620	6372	6593	6593	7036	6903	6903	6107	6770	6328	4425
	eff.	---	0.87	0.85	0.82	0.79	0.73	0.68	0.64	0.62	0.59	0.57	0.5
RS 130 5.12" CD	HP	---	24.98	19.61	14.08	10.90	8.55	6.87	5.20	4.69	3.52	3.02	2.18
	in-lb	---	8629	9470	9868	9868	10133	10753	9691	10133	8496	7877	7124
	eff.	---	0.88	0.86	0.83	0.81	0.75	0.7	0.67	0.68	0.63	0.58	0.57
RS 150 5.91" CD	HP	---	34.87	26.65	20.45	15.59	12.24	9.39	7.54	5.53	4.86	4.19	3.35
	in-lb	---	12036	13010	14470	14381	14691	15399	14160	12125	12302	11417	10886
	eff.	---	0.88	0.87	0.84	0.82	0.77	0.73	0.69	0.69	0.64	0.61	0.58

900 RPM input

Worm Gears RS-RT

8 poles - SF 1.0

RATINGS

900 RPM	Ratio	5	7	10	15	20	28	40	49	56	70	80	100
	output RPM	180	129	90	60	45	32	23	18	16	13	11	9
RS - RT 28 1.10" CD	HP	---	0.49	0.35	0.23	0.17	0.17	0.10	0.08	0.07	0.05	0.03	0.02
	in-lb	---	204	204	195	186	212	186	177	150	115	97	71
	eff.	---	0.81	0.77	0.71	0.69	0.6	0.55	0.51	0.44	0.4	0.39	0.36
RS - RT 40 1.57" CD	HP	1.68	1.24	0.91	0.65	0.44	0.40	0.28	0.23	0.20	0.17	0.15	0.12
	in-lb	522	513	513	513	434	487	434	407	398	381	363	336
	eff.	0.85	0.82	0.79	0.73	0.68	0.59	0.53	0.5	0.48	0.44	0.42	0.39
RS - RT 50 1.97" CD	HP	3.02	2.35	1.54	1.09	0.74	0.72	0.49	0.40	0.35	0.27	0.25	0.20
	in-lb	938	974	885	876	761	938	805	770	735	620	637	549
	eff.	0.86	0.83	0.8	0.75	0.71	0.64	0.57	0.542	0.52	0.45	0.44	0.39
RS - RT 60 2.36" CD	HP	4.69	3.35	2.68	1.84	1.46	1.22	0.82	0.59	0.57	0.44	0.40	0.28
	in-lb	1460	1451	1566	1575	1549	1655	1460	1239	1230	1133	1062	885
	eff.	0.87	0.84	0.81	0.77	0.74	0.67	0.62	0.59	0.54	0.51	0.46	0.44
RS - RT 70 2.76" CD	HP	6.54	4.53	3.52	2.35	1.84	1.68	1.19	0.92	0.77	0.60	0.54	0.40
	in-lb	2071	1912	2062	2044	1991	2266	2168	1947	1743	1558	1478	1328
	eff.	0.87	0.85	0.82	0.78	0.75	0.68	0.63	0.6	0.56	0.51	0.48	0.45
RS - RT 85 3.35" CD	HP	10.39	7.71	5.87	4.19	3.18	2.51	2.01	1.56	1.31	0.99	0.94	0.74
	in-lb	3292	3275	3540	3611	3434	3540	3717	3354	3124	2744	2699	2434
	eff.	0.87	0.85	0.83	0.79	0.76	0.69	0.65	0.61	0.59	0.55	0.5	0.46
RS - RT 110 4.33" CD	HP	---	14.25	11.40	8.21	6.54	5.53	3.86	3.35	2.85	2.51	2.01	1.32
	in-lb	---	6195	6903	7036	7213	7877	7257	7434	6815	7213	6372	4558
	eff.	---	0.86	0.84	0.8	0.77	0.71	0.66	0.62	0.6	0.57	0.55	0.48
RS 130 5.12" CD	HP	---	21.46	17.27	12.40	9.39	7.38	6.03	4.53	4.02	3.02	2.68	1.84
	in-lb	---	9381	10620	10886	10753	10620	11682	10487	10753	9116	8452	7567
	eff.	---	0.87	0.85	0.81	0.8	0.72	0.68	0.65	0.66	0.61	0.56	0.55
RS 150 5.91" CD	HP	---	30.17	22.96	17.77	13.58	10.39	8.21	6.37	5.03	4.36	3.86	2.85
	in-lb	---	13054	14249	15974	15753	15842	16727	15134	13585	13275	12611	11284
	eff.	---	0.87	0.86	0.83	0.81	0.75	0.71	0.68	0.67	0.61	0.58	0.56

Helical Worm Gears RA-TA

Helical Attachment 3.5:1

RATINGS

1800 RPM input - SF=1.0

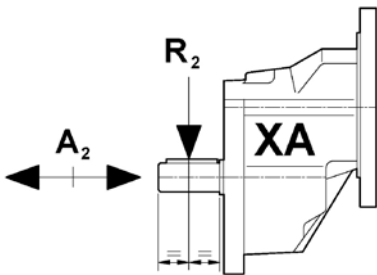
XA	Ratio	3.5	6.3	8	<p style="text-align: center;">Helical Single-Stage Attachment XA (XA63, XA71 & XA80 available with IEC input only)</p>  <p style="text-align: center;">Input Overhung Load (OHL) R_2 [lb] Output Axial Load $A_2 = 0.2 \times R_2$ [lb]</p>								
	RPM	514	286	225									
XA63	HP	0.84	0.39	0.30									
	in-lb	106	89	80									
	R_2 [lb]	8435	9732	9732									
XA71	HP	1.84	0.87	0.62									
	in-lb	230	195	177									
	R_2 [lb]	10597	12111	12111									
XA80	HP	5.20	2.51	1.84									
	in-lb	602	575	531									
	R_2 [lb]	13193	15139	15139									
XA100	HP	14.58	6.71	3.69									
	in-lb	2080	1443	1204									
	R_2 [lb]	44979	31198	26030									

Helical/worm gearbox

Ratio ₁ 3.5:1	Tot.ratio	18	25	35	53	70	98	140	172	196	245	280	350
	Ratio ₂	5	7	10	15	20	28	40	49	56	70	80	100
	RPM	100	72	51	34	26	18	13	10	9	7	6	5
63/40	HP	0.94	0.92	0.67	0.47	0.34	0.32	0.22	0.18	0.17	0.10	0.08	0.05
	in-lb	0.37	637	637	620	531	620	566	513	496	372	310	221
	eff.	0.80	0.78	0.75	0.7	0.63	0.56	0.5	0.46	0.44	0.41	0.4	0.35
63/50 71/50	HP	1.37	1.71	1.17	0.84	0.55	0.54	0.35	0.34	0.27	0.18	0.15	0.10
	in-lb	1270	1195	1124	1106	929	1106	929	1018	885	708	620	443
	eff.	0.81	0.79	0.76	0.7	0.66	0.59	0.52	0.5	0.46	0.42	0.4	0.35
63/60 71/60 80/60	HP	2.70	2.56	1.98	1.39	0.96	0.89	0.55	0.45	0.39	0.32	0.25	0.17
	in-lb	1940	1814	1920	1903	1699	1920	1566	1505	1345	1283	974	752
	eff.	0.82	0.8	0.77	0.72	0.7	0.61	0.57	0.54	0.49	0.45	0.38	0.36
71/70 80/70	HP	3.57	3.29	2.48	1.81	1.29	1.21	0.84	0.72	0.60	0.50	0.44	0.32
	in-lb	2500	2345	2434	2522	2301	2744	2390	2390	2080	1991	1770	1593
	eff.	0.83	0.81	0.78	0.74	0.71	0.64	0.57	0.54	0.49	0.45	0.41	0.39
71/85 80/85	HP	5.5	5.26	4.01	2.97	2.30	1.86	1.34	1.09	0.97	0.82	0.67	0.44
	in-lb	3900	3806	3983	4204	4160	4204	3938	3717	3629	3452	3009	2213
	eff.	0.84	0.82	0.79	0.75	0.72	0.64	0.58	0.55	0.53	0.48	0.44	0.4
80/110 100/110	HP	---	10.09	7.76	6.00	4.38	3.65	2.68	2.13	1.88	1.44	1.44	0.91
	in-lb	---	7390	7921	8408	8054	8496	8408	7523	7257	6638	6549	4779
	eff.	---	0.83	0.81	0.74	0.73	0.66	0.62	0.57	0.55	0.52	0.45	0.42
100/130	HP	---	11.73	11.40	9.22	6.37	5.20	3.86	2.85	2.51	2.18	1.84	1.34
	in-lb	---	8629	11682	13231	11948	12656	12213	11505	11063	10620	9558	7788
	eff.	---	0.83	0.81	0.77	0.75	0.67	0.63	0.64	0.62	0.6	0.5	0.48
100/150	HP	---	13.24	13.07	12.57	9.55	7.54	5.53	4.53	4.02	3.02	2.68	1.68
	in-lb	---	11415	13585	18497	18231	18851	18143	18054	17921	15045	12912	10620
	eff.	---	0.84	0.82	0.79	0.76	0.69	0.66	0.64	0.62	0.6	0.52	0.5

Helical Attachment 6.3:1

Helical Worm Gears RA-TA

1800 RPM input - SF=1.0

RATINGS

Ratio ₁ 6.3:1	Total ratio	32	44	63	95	126	176	252	309	353	441	504	630
	Ratio ₂	5	7	10	15	20	28	40	49	56	70	80	100
	RPM	56	41	29	19	14	10	7	6	5	4	4	3
63/40	HP	0.60	0.59	0.42	0,28	0,20	0,18	0,13	0,10	0,10	0,08	0,07	0,05
	in-lb	699	699	690	655	558	611	558	504	487	469	451	407
	eff.	0.78	0.76	0.72	0,67	0,6	0,52	0,45	0,43	0,39	0,35	0,34	0,31
63/50 71/50	HP	1.09	1,04	0,70	0,50	0,34	0,34	0,23	0,18	0,17	0,15	0,12	0,08
	in-lb	1320	1283	1177	1151	1000	1221	1018	956	885	814	788	637
	eff.	0.80	0,78	0,74	0,67	0,63	0,55	0,48	0,45	0,42	0,36	0,36	0,31
63/60 71/60 80/60	HP	1.63	1,54	1,24	0,87	0,67	0,59	0,39	0,27	0,27	0,18	0,17	0,13
	in-lb	1980	1929	2097	2080	2036	2106	1859	1416	1549	1248	1151	1080
	eff.	0.81	0,79	0,75	0,7	0,67	0,57	0,53	0,49	0,45	0,42	0,37	0,35
71/70 80/70	HP	2.08	2,01	1,59	1,14	0,84	0,74	0,54	0,44	0,39	0,30	0,28	0,20
	in-lb	2600	2558	2744	2744	2584	2832	2292	2407	2248	1956	1859	1682
	eff.	0.82	0,8	0,76	0,71	0,68	0,6	0,54	0,5	0,46	0,42	0,37	0,36
71/85 80/85	HP	3.48	3,35	2,68	1,84	1,41	1,16	0,89	0,72	0,62	0,47	0,44	0,37
	in-lb	4400	4337	4655	4567	4381	4434	4425	4124	3974	3460	3363	3053
	eff.	0.82	0,8	0,77	0,72	0,69	0,6	0,55	0,51	0,5	0,46	0,42	0,36
80/110 100/110	HP	---	7,21	5,36	4,02	3,02	2,68	1,84	1,68	1,34	1,11	0,85	0,54
	in-lb	---	9116	9735	10178	9735	10355	9824	9735	8806	8408	6903	4868
	eff.	---	0,81	0,79	0,74	0,71	0,63	0,57	0,53	0,52	0,48	0,45	0,39
100/130	HP	---	10,74	8,28	6,24	4,54	3,97	2,77	2,46	2,10	1,71	1,37	0,79
	in-lb	---	14160	15045	15930	15045	15930	15045	15045	14160	14160	11505	7965
	eff.	---	0,83	0,8	0,75	0,73	0,63	0,6	0,55	0,53	0,52	0,46	0,45
100/150	HP	---	14,10	11,08	8,45	6,32	5,06	3,87	3,05	2,36	2,08	1,83	1,41
	in-lb	---	18585	20355	22125	21240	21240	22125	20355	17700	15930	15930	15045
	eff.	---	0,83	0,81	0,77	0,74	0,66	0,63	0,6	0,59	0,81	0,48	0,47

Helical Worm Gears RA-TA

Helical Attachment 8:1

RATINGS

1800 RPM input - SF=1.0

Ratio ₁ 8:1	Total ratio	40	56	80	120	160	224	320	392	448	560	640	800
	Ratio ₂	5	7	10	15	20	28	40	49	56	70	80	100
	RPM	45	32	23	15	11	8.0	6.6	4.6	4.0	3.2	2.8	2,2
63/40	HP	0.55	0.54	0.39	0.27	0.18	0.18	0.13	0.10	0.08	0.05	0.05	0.03
	in-lb	823	823	788	743	637	752	664	611	522	398	336	239
	eff.	0.71	0.75	0.72	0.65	0.59	0.5	0.44	0.41	0.38	0.36	0.34	0.31
63/50 71/50	HP	1.05	0.97	0.69	0.47	0.34	0.30	0.22	0.17	0.15	0.10	0.08	0.05
	in-lb	1620	1505	1460	1363	1151	1328	1151	1062	1018	761	646	469
	eff.	0.79	0.77	0.73	0.67	0.61	0.55	0.47	0.45	0.41	0.36	0.37	0.31
63/60 71/60 80/60	HP	1.6	1.46	1.14	0.82	0.57	0.52	0.35	0.27	0.25	0.17	0.13	0.08
	in-lb	2480	2301	2478	2434	2124	2390	2080	1947	1770	1372	1106	814
	eff.	0.80	0.78	0.75	0.69	0.65	0.57	0.51	0.5	0.43	0.41	0.37	0.35
71/70 80/70	HP	2.31	2.11	1.47	1.06	0.74	0.80	0.50	0.40	0.34	0.27	0.20	0.08
	in-lb	3560	3363	3230	3186	2876	3894	2832	2832	2434	2168	1770	1283
	eff.	0.81	0.79	0.76	0.7	0.67	0.6	0.53	0.5	0.45	0.41	0.38	0.35
71/85 80/85	HP	3.2	2.95	2.38	1.79	1.42	1.09	0.80	0.67	0.55	0.44	0.34	0.22
	in-lb	5050	4691	5266	5487	5487	5310	4956	4868	4514	3983	3186	2301
	eff.	0.81	0.79	0.77	0.71	0.67	0.6	0.54	0.52	0.5	0.45	0.41	0.37
80/110 100/110	HP	---	5.73	4.61	3.30	2.55	2.16	1.63	1.22	1.07	0.87	0.72	0.45
	in-lb	---	9248	10355	10443	10266	10620	10443	9027	8673	8142	7523	4868
	eff.	---	0.8	0.78	0.73	0.7	0.61	0.56	0.52	0.5	0.46	0.45	0.38
100/130	HP	---	5.53	5.03	5.36	3.86	3.02	2.01	1.84	1.51	1.17	1.17	0.84
	in-lb	---	8850	10974	16284	15620	15576	15045	14691	14160	12700	11771	10266
	eff.	---	0.8	0.78	0.73	0.72	0.62	0.58	0.56	0.54	0.51	0.45	0.43
100/150	HP	---	6.20	5.70	6.03	5.70	4.53	3.35	2.85	2.35	1.84	1.68	1.34
	in-lb	---	10001	12611	19028	22833	23674	25311	22568	22037	18674	17435	16417
	eff.	---	0.81	0.79	0.75	0.72	0.63	0.61	0.56	0.57	0.49	0.46	0.45

Double Worm Gears RS-RT

1800 RPM input - SF=1.0

RATINGS

	Ratio ₁	10	15	20	28	40	56	56	70	100	100	100	100
	Ratio ₂	28	28	28	28	28	28	40	40	40	56	80	100
	Total R	280	420	560	784	1120	1568	2240	2800	4000	5600	8000	10000
	RPM	6.4	4,3	3,2	2,3	1,6	1,2	0,80	0,64	0,45	0,32	0,23	0,18
RS - RT 28 / 28	HP	0.055	0.05	0.04	0.04	0.03	0.02	0.02	0.01	0.01	0.005	0.003	0.002
	in-lb	300	310	319	319	319	310	266	266	266	142	106	97
	eff.	0.40	0.38	0.37	0.32	0.3	0.25	0.21	0.20	0.18	0.14	0.12	0.13
RS - RT 28 / 40	HP	0.14	0.13	0.10	0.08	0.06	0.05	0.04	0.04	0.02	0.02	0.008	0.005
	in-lb	740	752	752	708	708	708	646	673	620	549	363	221
	eff.	0.42	0.39	0.37	0.33	0.31	0.25	0.21	0.18	0.18	0.15	0.14	0.12
RS - RT 28 / 50	HP	0.24	0.22	0.18	0.15	0.12	0.10	0.06	0.06	0.05	0.03	0.02	0.01
	in-lb	1300	1328	1328	1416	1549	1416	1106	1159	1301	1106	690	434
	eff.	0.42	0.39	0.37	0.33	0.31	0.25	0.22	0.19	0.19	0.16	0.14	0.12
RS - RT 28 / 60	HP	0.36	0.33	0.26	0.22	0.15	0.15	0.11	0.09	0.05	0.05	0.03	0.02
	in-lb	2050	2124	2124	2168	2036	2301	2168	1920	1451	1726	1133	805
	eff.	0.45	0.42	0.4	0.35	0.33	0.27	0.23	0.21	0.2	0.16	0.14	0.13
RS - RT 40 / 70	HP	0.55	0.50	0.42	0.33	0.26	0.20	0.14	0.12	0.10	0.07	0.04	0.03
	in-lb	3100	3363	3540	3540	3496	3363	3275	3053	3186	2841	1779	1363
	eff.	0.46	0.44	0.42	0.38	0.33	0.3	0.27	0.25	0.22	0.2	0.15	0.14
RS - RT 40 / 85	HP	0.8	0.75	0.62	0.46	0.38	0.30	0.23	0.20	0.15	0.12	0.07	0.04
	in-lb	5100	5266	5531	5177	5531	5399	5443	5266	5000	4868	3301	2336
	eff.	0.49	0.46	0.44	0.4	0.35	0.32	0.28	0.26	0.23	0.2	0.17	0.15
RS - RT 50 / 110	HP	1.6	1.45	1.27	0.97	0.76	0.64	0.49	0.39	0.27	0.21	0.14	0.09
	in-lb	10200	10532	11505	11505	11328	11948	11859	10709	9470	8673	7169	4956
	eff.	0.50	0.48	0.45	0.42	0.37	0.33	0.3	0.27	0.24	0.2	0.18	0.16
RS 60 / 130	HP	2.7	2.51	1.84	1.26	0.92	0.92	0.62	0.42	0.42	0.42	0.42	0.42
	in-lb	17100	17833	17081	14780	13541	17833	16196	12479	15665	16373	12567	10841
	eff.	0.53	0.5	0.46	0.43	0.4	0.35	0.33	0.3	0.27	0.25	0.21	0.2
RS 70 / 150	kW	3.3	3.02	2.51	1.84	1.26	1.26	0.92	0.62	0.62	0.42	0.42	0.42
	in-lb	27400	22745	25046	22745	21771	25223	26727	20576	25444	23630	18895	17656
	eff.	0.55	0.52	0.5	0.46	0.43	0.39	0.36	0.33	0.31	0.27	0.23	0.22

Worm Gears RS

DIMENSIONS

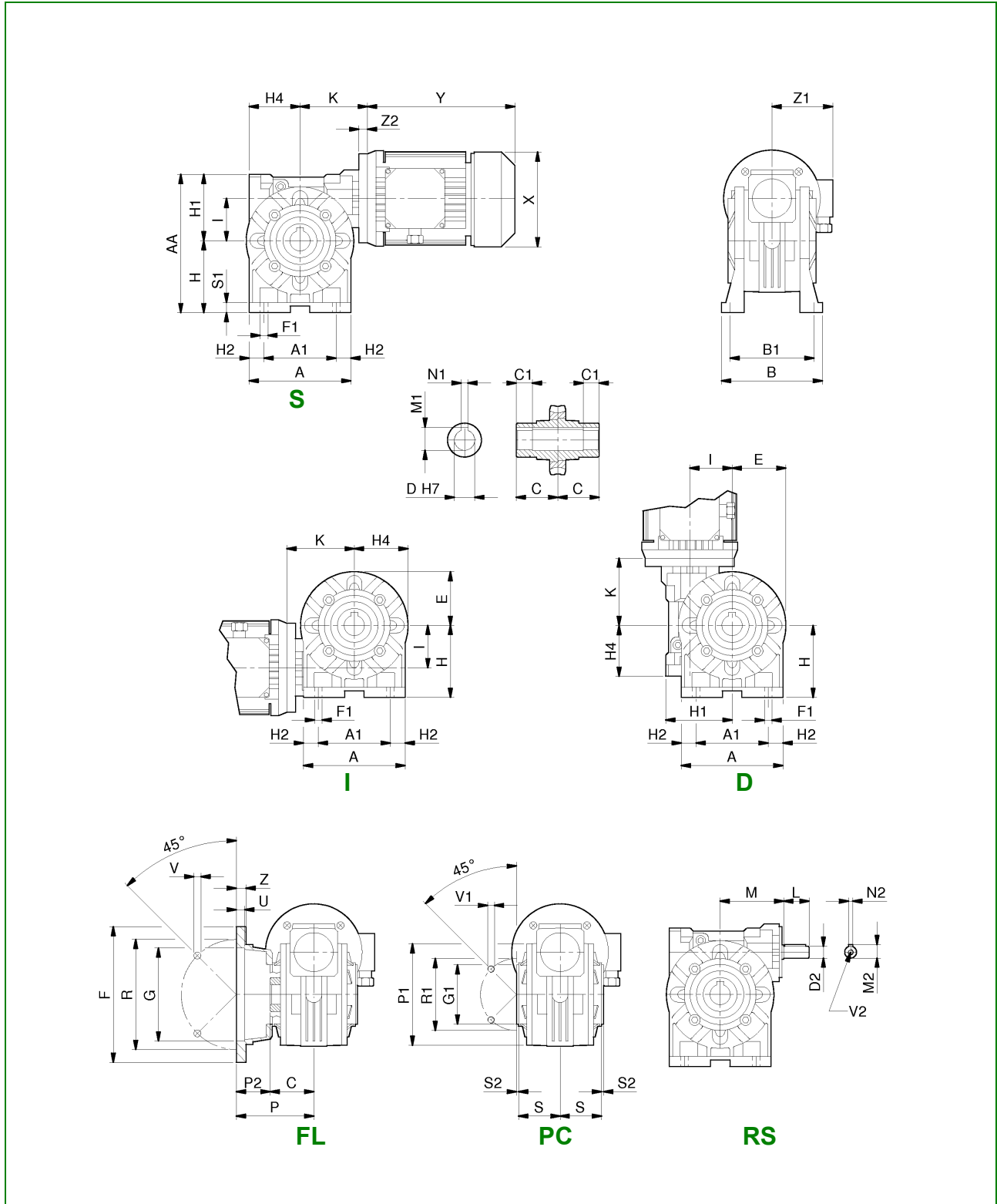

Worm Gears RS

DIMENSIONS

RS	28 (1.10)	40 (1.57)	50 (1.97)	60 (2.36)	70 (2.76)	85 (3.35)	110 (4.33)	130 (5.12)	150 (5.91)
A	2.76	3.94	4.72	5.43	6.22	7.60	9.84	11.26	13.23
A ₁	2.05	2.76	3.35	3.74	4.72	5.51	7.87	9.25	10.24
AA	3.90	5.43	6.42	7.56	8.70	9.92	13.11	15.75	17.87
B	3.07	4.02	4.69	5.35	#	6.61	7.87	9.06	9.84
B ₁	2.60	3.31	3.90	4.37	4.57	5.51	6.38	7.48	8.27
C	1.18	1.61	1.93	2.36	2.36	2.40	3.05	3.54	4.13
D _(H7)	0.625	0.75	1.0	1.125	1.25	1.375	1.625	1.75	2.0
D_(H7)	14	19 (18)	24 (25)	25	28 (30)	32 (35)	42	48	55
D_{2 (h6)}	9	11	14	19	19	24	28	38	42
E	1.34	1.97	2.40	2.76	3.15	3.86	4.92	5.63	6.61
F	2.76	5.51	6.30	7.09	7.87	7.87	9.84	11.81	13.78
F ₁	0.22	0.28	0.35	0.43	0.43	0.51	0.55	0.59	0.75
G _(H8)	1.57	3.74	4.33	4.53	5.12	5.12	7.09	9.06	9.84
G _{1 (f8)}	1.65	2.36	2.76	2.76	3.15	4.33	5.12	7.09	7.09
H	2.05	2.80	3.35	3.94	4.53	5.31	6.77	7.87	9.06
H ₁	1.85	2.64	3.07	3.62	4.17	4.61	6.34	7.87	8.82
H ₂	0.35	0.59	0.69	0.85	0.75	1.04	0.98	1.00	1.50
H ₄	1.57	1.97	2.36	2.83	3.39	4.06	5.47	6.26	7.20
I	1.10	1.57	1.97	2.36	2.76	3.35	4.33	5.12	5.91
K	2.60	3.27	3.82	4.06	4.96	6.30	5.94	6.81	7.52
L	0.79	0.91	1.18	1.57	1.57	1.97	2.36	3.15	3.94
M	1.97	2.56	2.95	3.43	4.33	4.86	5.75	6.54	7.68
M ₁	0.71	0.84	1.12	1.25	1.37	1.52	1.80	1.93	2.27
M ₂	0.40	0.49	0.63	0.89	0.89	1.06	1.22	1.61	1.77
N ₁	0.19	0.19	0.25	0.25	0.251	0.31	0.38	0.38	0.5
N ₂	0.12	0.16	0.20	0.24	0.24	0.31	0.31	0.39	0.47
P	1.93	3.23	3.60	4.57	4.37	3.94	5.91	5.91	6.30
P ₁	2.64	3.70	3.94	4.02	4.65	5.91	7.87	9.21	9.84
P ₂	0.75	1.61	1.67	2.20	2.01	1.54	2.85	2.36	2.17
R	2.20	4.53	5.12	5.91	6.50	6.50	8.46	10.43	11.81
R ₁	2.20	3.27	3.35	3.35	3.94	5.12	6.50	8.46	8.46
S	1.26	1.50	1.93	2.26	2.24	2.22	2.93	3.43	4.02
S ₁	0.24	0.35	0.47	0.47	0.55	0.59	0.67	0.75	0.79
S ₂	- 0.12	0.08	0.10	0.10	0.12	0.12	0.10	0.20	0.20
U	0.16	0.24	0.39	0.39	0.47	0.24	0.20	0.20	0.24
V	0.26 (4x)	0.35 (4x)	0.35 (4x)	0.43 (4x)	0.51 (4x)	0.51 (4x)	0.59 (8x)	0.59 (8x)	0.75 (8x)
V₁	M6x6 (4x)	M6x9 (4x)	M8x12 (4x)	M8x15 (8x)	M8x18 (8x)	M10x20 (8x)	M12x21 (8x)	M12x24 (8x)	M14x30 (8x)
V₂	M4x10	M4x10	M6x15	M8x20	M8x20	M8x20	M8x20	M10x22	M12x25
Z	0.24	0.39	0.39	0.43	0.55	0.55	0.63	0.87	0.79

- # - 5.39 - Bolted feet / 5.51 - Integral feet
 - V₁ - 90° for RS28
 - Motor dimensions (X, Y, Z1) refer to manufacturer's catalogue
 - Not binding dimensions, for reference only

- Dimensions are inch / mm

Helical Worm Gears RA

DIMENSIONS

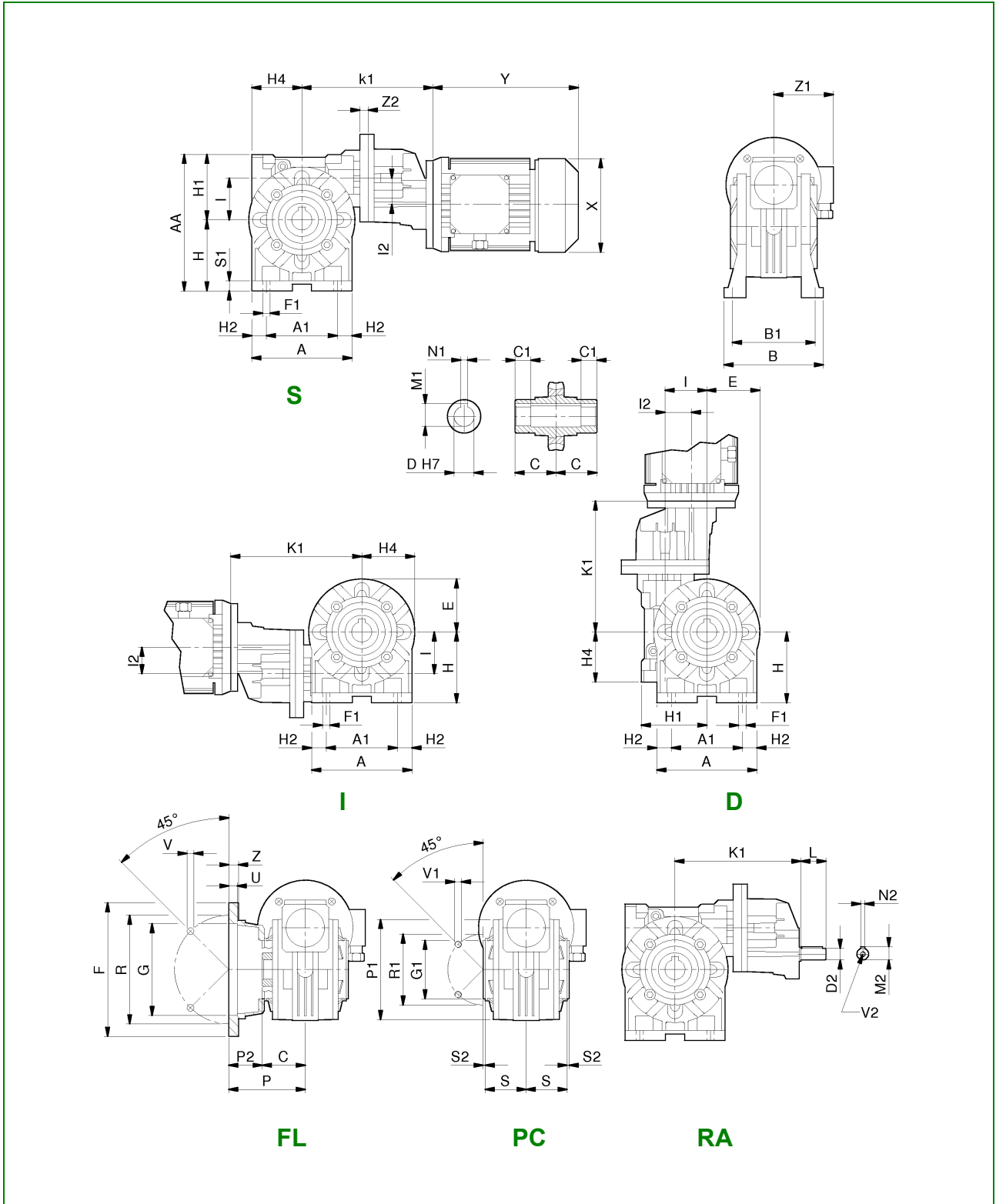

Helical Worm Gears RA

DIMENSIONS

RA	63 (IEC input only) /			71 (IEC input only) /				80 (IEC input only) /				100 /		
	40 (1.57)	50 (1.97)	60 (2.36)	50 (1.97)	60 (2.36)	70 (2.76)	85 (3.35)	60 (2.36)	70 (2.76)	85 (3.35)	110 (4.33)	110 (4.33)	130 (5.12)	150 (5.91)
A	3.94	4.72	5.43	4.72	5.43	6.22	7.60	5.43	6.22	7.60	9.84	9.84	11.26	13.23
A ₁	2.76	3.35	3.74	3.35	3.74	4.72	5.51	3.74	4.72	5.51	7.87	7.87	9.25	10.24
AA	5.43	6.42	7.56	6.42	7.56	8.70	9.92	7.56	8.70	9.92	13.11	13.11	15.75	17.87
B	4.02	4.69	5.35	4.69	5.35	#	6.61	5.35	#	6.61	7.87	7.87	9.06	9.84
B ₁	3.31	3.90	4.37	3.90	4.37	4.57	5.51	4.37	4.57	5.51	6.38	6.38	7.48	8.27
C	1.61	1.93	2.36	1.93	2.36	2.36	2.40	2.36	2.36	2.40	3.05	3.05	3.54	4.13
D _(H7)	0.75	1.0	1.125	1.0	1.125	1.25	1.375	1.125	1.25	1.375	1.625	1.625	1.75	2.0
D_(H7)	19 (18)	24 (25)	25	24 (25)	25	28 (30)	32 (35)	25	28 (30)	32 (35)	42	42	48	55
D₂ (h6)	11	11	11	14	14	14	14	19	19	19	19	24	24	24
E	1.97	2.40	2.76	2.40	2.76	3.15	3.86	2.76	3.15	3.86	4.92	4.92	5.63	6.61
F	5.51	6.30	7.09	6.30	7.09	7.87	7.87	7.09	7.87	7.87	9.84	9.84	11.81	13.78
F ₁	0.28	0.35	0.43	0.35	0.43	0.43	0.51	0.43	0.43	0.51	0.55	0.55	0.59	0.75
G _(H8)	3.74	4.33	4.53	4.33	4.53	5.12	5.12	4.53	5.12	5.12	7.09	7.09	9.06	9.84
G _{1 (f8)}	2.36	2.76	2.76	2.76	2.76	3.15	4.33	2.76	3.15	4.33	5.12	5.12	7.09	7.09
H	2.80	3.35	3.94	3.35	3.94	4.53	5.31	3.94	4.53	5.31	6.77	6.77	7.87	9.06
H ₁	2.64	3.07	3.62	3.07	3.62	4.17	4.61	3.62	4.17	4.61	6.34	6.34	7.87	8.82
H ₂	0.59	0.69	0.85	0.69	0.85	0.75	1.04	0.85	0.75	1.04	0.98	0.98	1.00	1.50
H ₄	1.97	2.36	2.83	2.36	2.83	3.39	4.06	2.83	3.39	4.06	5.47	5.47	6.26	7.44
I	1.57	1.97	2.36	1.97	2.36	2.76	3.35	2.36	2.76	3.35	4.33	4.33	5.12	5.91
I ₂	1.26	1.26	1.26	1.57	1.57	1.57	1.57	1.97	1.97	1.97	1.97	2.48	2.48	2.48
K ₁	6.04	6.73	6.97	6.81	7.20	8.23	8.82	8.15	9.15	9.86	10.41	12.91	13.46	14.49
L	0.91	0.91	0.91	1.18	1.18	1.18	1.18	1.57	1.57	1.57	1.57	1.97	1.97	1.97
M ₁	0.84	1.12	1.25	1.12	1.25	1.37	1.52	1.25	1.37	1.52	1.80	1.80	1.93	2.27
M ₂	0.49	0.49	0.49	0.63	0.63	0.63	0.63	0.89	0.89	0.89	0.89	1.06	1.06	1.06
N ₁	0.19	0.25	0.25	0.25	0.25	0.25	0.31	0.25	0.25	0.31	0.38	0.37	0.38	0.50
N ₂	0.16	0.16	0.16	0.20	0.20	0.20	0.20	0.24	0.24	0.24	0.24	0.31	0.31	0.31
P	3.23	3.60	4.57	3.60	4.57	4.37	3.94	4.57	4.37	3.94	5.91	5.91	5.91	6.30
P ₁	3.70	3.94	4.02	3.94	4.02	4.65	5.91	4.02	4.65	5.91	7.87	7.87	9.21	9.84
P ₂	1.61	1.67	2.20	1.67	2.20	2.01	1.54	2.20	2.01	1.54	2.85	2.85	2.36	2.17
R	4.53	5.12	5.91	5.12	5.91	6.50	6.50	5.91	6.50	6.50	8.46	8.46	10.43	11.81
R ₁	3.27	3.35	3.35	3.35	3.35	3.94	5.12	3.35	3.94	5.12	6.50	6.50	8.46	8.46
S	1.50	1.93	2.26	1.93	2.26	2.24	2.22	2.26	2.24	2.22	2.93	2.93	3.43	4.02
S ₁	0.35	0.47	0.47	0.47	0.47	0.55	0.59	0.47	0.55	0.59	0.67	0.67	0.75	0.79
S ₂	0.08	0.10	0.10	0.10	0.10	0.12	0.12	0.10	0.12	0.12	0.10	0.10	0.20	0.20
U	0.24	0.39	0.39	0.39	0.39	0.47	0.24	0.39	0.47	0.24	0.20	0.20	0.20	0.24
V	0.35 (4)	0.35 (4)	0.43 (4)	0.35 (4)	0.43 (4)	0.51 (4)	0.51 (4)	0.43 (4)	0.51 (4)	0.51 (4)	0.59 (8)	0.59 (8)	0.59 (8)	0.75 (8)
V₁	M6x9 (4x)	M8x12 (4x)	M8x15 (8x)	M8x12 (4x)	M8x15 (8x)	M8x18 (8x)	M10x20 (8x)	M8x15 (8x)	M8x18 (8x)	M10x20 (8x)	M12x21 (8x)	M12x21 (8x)	M12x24 (8x)	M14x30 (8x)
V₂	M4x10	M4x10	M4x10	M6x15	M6x15	M6x15	M6x15	M8x20	M8x20	M8x20	M8x20	M8x20	M8x20	M8x20
Y ₁	4.13	4.13	4.13	4.72	4.72	4.72	4.72	5.51	5.51	5.51	5.51	5.51	7.87	7.87
Z	0.39	0.39	0.43	0.39	0.43	0.55	0.55	0.43	0.55	0.55	0.63	0.63	0.71	0.79

- # - 5.39 - Bolted feet / 5.51 - Integral feet
 - V₁ - 90° for RS28
 - Motor dimensions (X, Y, Z1) refer to manufacturer's catalogue
 - Not binding dimensions, for reference only

- Dimensions are inch / mm

Double Worm Gears RS

DIMENSIONS

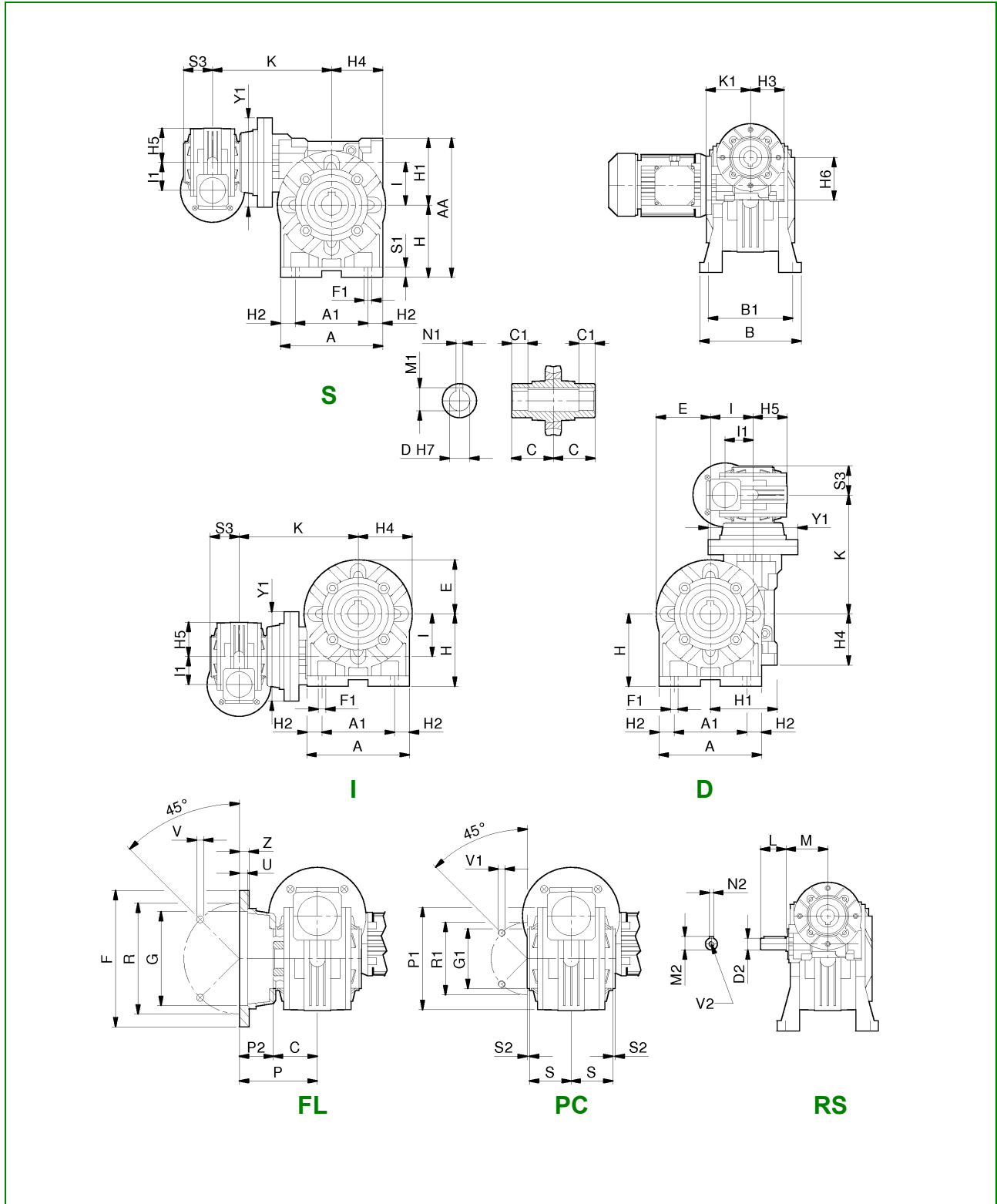

Double Worm Gears RS

DIMENSIONS

RS	28 /				40 /		50 /	60 /	70 /
	28	40	50	60	70	85	110	130	150
A	2.76	3.94	4.72	5.43	6.22	7.60	9.84	11.26	13.23
A ₁	2.05	2.76	3.35	3.74	4.72	5.51	7.87	9.25	10.24
AA	3.90	5.43	6.42	7.56	8.70	9.92	13.11	15.75	17.87
B	3.07	4.02	4.69	5.35	#	6.61	7.87	9.06	9.84
B ₁	2.60	3.31	3.90	4.37	4.57	5.51	6.38	7.48	8.27
C	1.18	1.61	1.93	2.36	2.36	2.40	3.05	3.54	4.13
D _(H7)	0.625	0.75	1.0	1.125	1.25	1.375	1.625	1.75	2.0
D_(H7)	14	19 (18)	24 (25)	25	28 (30)	32 (35)	42	48	55
D_{2 (h6)}	9	9	9	9	11	11	14	19	19
E	1.34	1.97	2.40	2.76	3.15	3.86	4.92	5.63	6.61
F	2.76	5.51	6.30	7.09	7.87	7.87	9.84	11.81	13.78
F ₁	0.22	0.28	0.35	0.43	0.43	0.51	0.55	0.59	0.75
G _(H8)	1.57	3.74	4.33	4.53	5.12	5.12	7.09	9.06	9.84
G _{1 (f8)}	1.65	2.36	2.76	2.76	3.15	4.33	5.12	7.09	7.09
H	2.05	2.80	3.35	3.94	4.53	5.31	6.77	7.87	9.06
H ₁	1.85	2.64	3.07	3.62	4.17	4.61	6.34	7.87	8.82
H ₂	0.35	0.59	0.69	0.85	0.75	1.04	0.98	1.00	1.50
H ₃	1.57	1.57	1.57	1.57	1.97	1.97	2.36	2.83	3.39
H ₄	1.57	1.97	2.36	2.83	3.39	4.06	5.47	6.26	7.44
H ₅	1.34	1.34	1.34	1.34	1.97	1.97	2.40	2.76	3.15
H ₆	1.85	1.85	1.85	1.85	2.64	2.64	3.07	3.62	4.17
I	1.10	1.57	1.97	2.36	2.76	3.35	4.33	5.12	5.91
I ₂	1.10	1.10	1.10	1.10	1.57	1.57	1.97	2.36	2.76
K	3.92	4.57	5.45	5.75	7.17	7.83	9.69	9.69	11.81
K ₁	2.26	2.26	2.26	2.26	2.78	2.78	3.27	3.66	4.61
L	0.79	0.79	0.79	0.79	0.91	0.91	1.18	1.57	1.57
M	1.97	1.97	1.97	1.97	2.56	2.56	2.95	3.43	4.33
M ₁	0.71	0.84	1.12	1.25	1.37	1.52	1.80	1.93	2.27
M ₂	0.40	0.40	0.40	0.40	0.49	0.49	0.63	0.89	0.89
N ₁	0.19	0.19	0.25	0.25	0.25	0.31	0.38	0.38	0.50
N ₂	0.12	0.12	0.12	0.12	0.16	0.16	0.20	0.24	0.24
P	1.93	3.23	3.60	4.57	4.37	3.94	5.91	5.91	6.30
P ₁	2.64	3.70	3.94	4.02	4.65	5.91	7.87	9.21	9.84
P ₂	0.75	1.61	1.67	2.20	2.01	1.54	2.85	2.36	2.17
R	2.20	4.53	5.12	5.91	6.50	6.50	8.46	10.43	11.81
R ₁	2.20	3.27	3.35	3.35	3.94	5.12	6.50	8.46	8.46
S	1.26	1.50	1.93	2.26	2.24	2.22	2.93	3.43	4.02
S ₁	0.24	0.35	0.47	0.47	0.55	0.59	0.67	0.75	0.79
S ₂	-0.12	0.08	0.10	0.10	0.12	0.12	0.10	0.20	0.20
S ₃	1.18	1.18	1.18	1.18	1.61	1.61	1.93	2.36	2.36
U	0.16	0.24	0.39	0.39	0.47	0.24	0.20	0.20	0.24
V	0.24 (4x)	0.35 (4x)	0.35 (4x)	0.43 (4x)	0.51 (4x)	0.51 (4x)	0.59 (8x)	0.59 (8x)	0.75 (8x)
V₁	M6x6 (4x)	M6x9 (4x)	M8x12 (4x)	M8x15 (8x)	M8x18 (8x)	M10x20 (8x)	M12x21 (8x)	M12x24 (8x)	M14x30 (8x)
V₂	M4x10	M4x10	M4x10	M4x10	M4x10	M4x10	M6x15	M8x20	M8x20
Y ₁	3.15	3.15	3.15	3.54	4.53	4.53	4.33	7.09	7.87
Z	0.24	0.39	0.39	0.43	0.55	0.55	0.63	0.71	0.79

- # - 5.39 - Bolted feet / 5.51 - Integral feet - Not binding dimensions, for reference only

- V₁ - 90° for RS28 - Motor dimensions refer to manufacturer's catalogue

- Dimensions are inch / mm

Worm Gears RS

DIMENSIONS

ALTERNATIVE MOUNTINGS

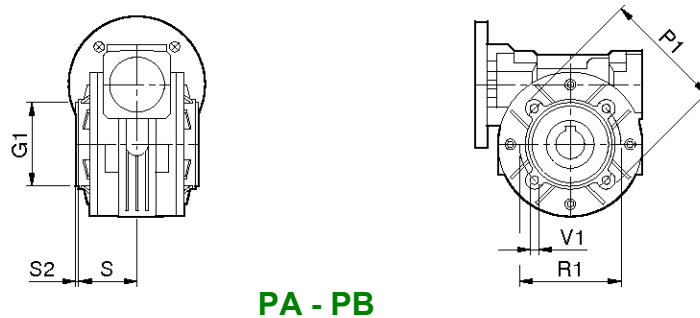
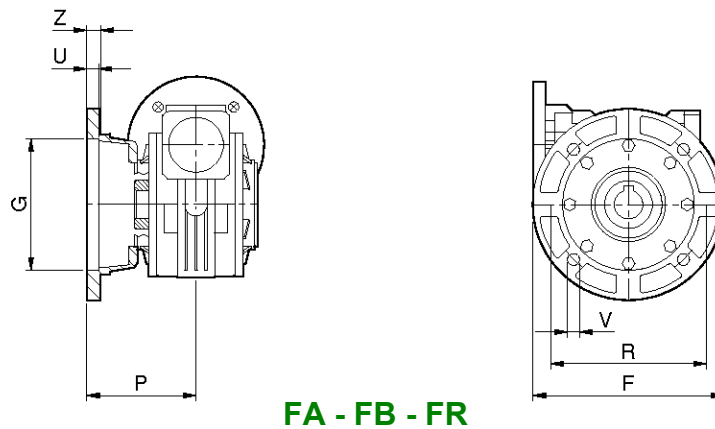
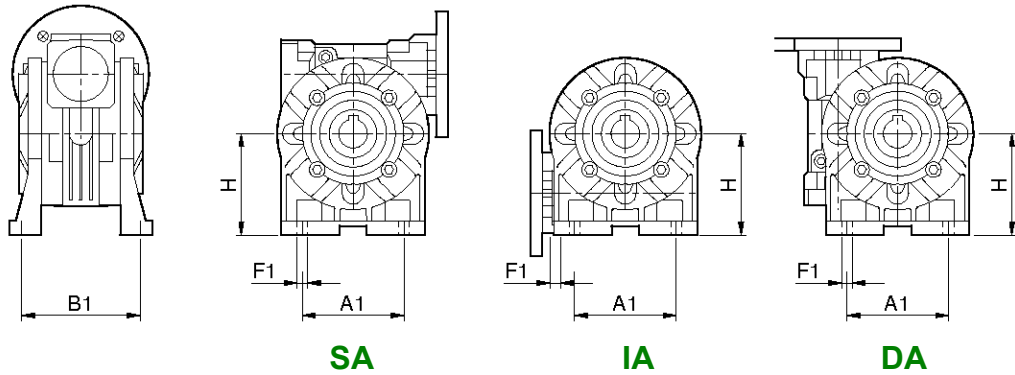

Worm Gears RS

ALTERNATIVE MOUNTINGS

DIMENSIONS

RS	28	40	50	60	70	85	110	130	150
SA - IA - DA									
A ₁	---	2.05	2.48	---	---	5.51	---	---	---
B ₁	---	3.19	3.88	---	---	5.75	---	---	---
F ₁	---	0.33	0.34	---	---	0.43	---	---	---
H	---	2.84	3.23	---	---	5.59	---	---	---
FA									
F	3.15	4.13	4.92	6.50	6.50	---	---	---	---
G _(H8)	1.97	2.36	2.76	4.33	4.53	---	---	---	---
P	1.99	2.72	3.66	3.54	4.57	---	---	---	---
R	2.68	3.43	3.54	5.12	5.91	---	---	---	---
U	0.14	0.20	0.20	0.39	0.18	---	---	---	---
V	0.26 (4x)	0.35 (4x)	0.43 (4x)	0.41 (4x)	0.43 (4x)	---	---	---	---
Z	0.28	0.31	0.39	0.59	0.39	---	---	---	---
FB									
F	---	4.72	---	7.09	---	8.27	10.63	---	---
G _(H8)	---	3.15	---	4.53	---	5.98	6.69	---	---
P	---	2.44	---	3.39	---	4.70	5.18	---	---
R	---	3.94	---	5.91	---	6.93	9.06	---	---
U	---	0.16	---	0.14	---	0.20	0.20	---	---
V	---	0.35 (4x)	---	0.43 (4x)	---	0.43 (4x)	0.52 (4x)	---	---
Z	---	0.35	---	0.47	---	0.55	0.71	---	---
FR									
F	---	---	---	---	6.30	---	---	---	---
G _(H8)	---	---	---	---	4.33	---	---	---	---
P	---	---	---	---	3.33	---	---	---	---
R	---	---	---	---	5.12	---	---	---	---
U	---	---	---	---	0.18	---	---	---	---
V	---	---	---	---	0.43 (4x)	---	---	---	---
Z	---	---	---	---	0.55	---	---	---	---
PA									
G _{1(h8)}	---	1.97	2.68	2.95	3.54	---	---	---	---
P ₁	---	3.74	4.33	4.09	4.92	---	---	---	---
R ₁	---	2.56	3.70	3.54	4.33	---	---	---	---
S	---	1.50	1.93	1.87	2.17	---	---	---	---
S ₂	---	0.08	0.10	0.22	0.12	---	---	---	---
V ₁	---	M6x8 (4x)	M6x12.5 (4x)	M8x14 (4x)	M8x14 (4x)	---	---	---	---
PB									
G _{1(h8)}	---	---	2.36	---	2.76	---	---	---	---
P ₁	---	---	4.33	---	4.57	---	---	---	---
R ₁	---	---	2.95	---	3.35	---	---	---	---
S	---	---	1.93	---	2.64	---	---	---	---
S ₂	---	---	0.10	---	0.16	---	---	---	---
V ₁	---	---	M6x12.5 (4x)	---	M8x14 (4x)	---	---	---	---

- Not binding dimensions, for reference only

- Dimensions are inch / mm

Worm Gears RS

DIMENSIONS

ACCESSORIES

AS
Solid single
output shaft

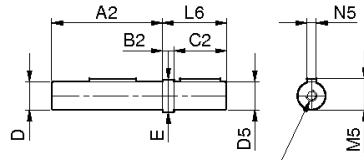

AD
Solid double
output shaft

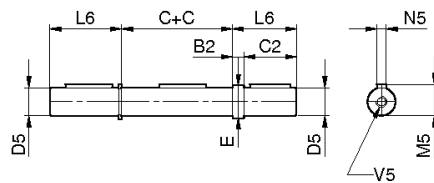

ASC
Safety cap for AS

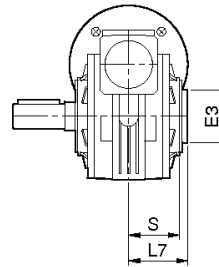

BR
Torque arm

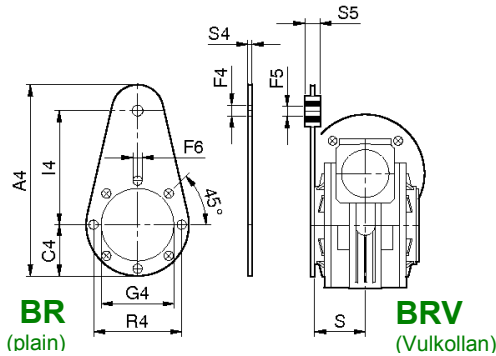

SL
Speed Limiter

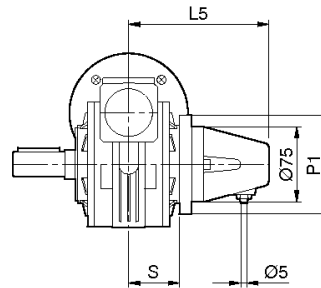

TL
Torque Limiter

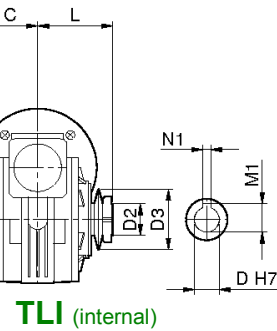
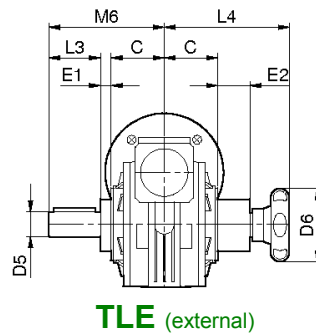

VB
NDE wormshaft
extension

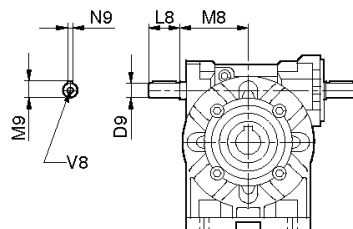

TLI LUBRICATION

Size	US qt	litres
28	0.04	0.04
40	0.10	0.10
50	0.14	0.13
60	0.31	0.30
70	0.48	0.45
85	0.79	0.75
110	2.38	2.25

Worm Gears RS

ACCESSORIES

DIMENSIONS

RS	28	40	50	60	70	85	110	130	150
AS & AD A ₂	2.28	3.16	3.74	4.61	4.61	4.69	6.02	6.97	8.15
B ₂	0.08	0.39	0.39	0.39	0.39	0.39	0.39	0.79	0.79
C	1.18	1.61	1.93	2.36	2.36	2.40	3.05	3.54	4.13
C ₂	1.375	1.57	1.97	2.36	2.36	2.76	3.15	3.54	3.94
D _{5 (g6)}	0.625	0.75	1.0	1.125	1.25	1.375	1.625	1.75	2.0
D_{5 (g6)}	14	19 (18)	24 (25)	25	28 (30)	32 (35)	42	48	55
E	0.82	0.98	1.25	1.37	1.49	1.69	1.95	2.28	2.48
L ₆	1.42	1.97	2.37	2.76	2.76	3.15	3.54	4.33	4.33
M ₅	0.70	0.83	1.10	1.23	1.36	1.51	1.79	1.91	2.21
N ₅ x N ₅	3/16	3/16	1/4	1/4	1/4	5/16	3/8	3/8	1/2
V ₅	1/4"-20	1/4"-20	3/8"-16	3/8"-16	1/2"-13	1/2"-13	5/8"-11	5/8"-11	3/4"-10
ASC E ₃	1.65	2.17	2.44	2.44	2.83	3.54	4.72	---	---
L ₇	1.42	1.91	2.19	2.70	2.64	3.03	3.35	---	---
S	1.08	1.52	1.83	2.24	2.24	2.64	2.91	---	---
BR & BRV A ₄	5.26	6.61	7.28	9.06	9.45	12.32	15.28	18.31	20.67
C ₄	1.32	1.69	2.36	1.97	2.36	2.95	3.94	4.72	4.92
F ₄	0.41	0.41	0.41	0.41	0.41	0.81	0.81	1.02	1.02
F ₅	0.39	0.39	0.39	0.39	0.39	0.79	0.79	0.98	0.98
F ₆	0.28	0.28	0.35	0.35	0.35	0.43	0.51	0.51	0.59
G ₄	1.65	2.36	2.76	2.76	3.15	4.33	5.12	7.09	7.09
I ₄	3.15	3.54	3.94	5.91	5.91	7.87	9.84	11.81	13.78
R ₄	2.20	2.95	3.35	3.35	3.94	5.12	6.50	8.46	8.46
S ₄	0.16	0.16	0.16	0.24	0.24	0.24	0.24	0.24	0.24
S ₅	0.59	0.59	0.59	0.79	0.79	0.98	0.98	1.18	1.18
SL L ₅	3.82	4.49	5.08	5.39	5.24	5.24	5.94	---	---
P ₁	2.64	3.94	4.33	4.02	4.72	5.91	7.87	---	---
S	1.26	1.50	1.93	2.26	2.24	2.22	2.93	---	---
TLE D ₆	2.05	2.76	2.76	2.76	3.15	3.94	3.94	---	---
E ₁	0.39	0.47	0.47	0.59	0.55	0.75	0.94	---	---
E ₂	1.10	1.46	1.22	1.57	1.81	2.24	2.80	---	---
L ₃	1.18	1.57	1.97	1.97	2.36	2.76	3.15	---	---
L ₄	3.70	4.57	4.65	5.04	5.75	6.61	7.91	---	---
M ₆	2.76	3.66	4.37	4.92	5.28	5.91	7.13	---	---
TLI D	14	18	24	25	28	32	42	---	---
D ₂	1.57	2.20	2.80	2.80	3.15	3.54	4.92	---	---
D ₃	0.56 x 0.79	0.77 x 0.81	0.97 x 1.10	1.00 x 1.02	1.12 x 0.87	1.28 x 1.06	1.67 x 1.52	---	---
L	1.77	2.42	3.03	3.41	3.50	3.70	4.43	---	---
M ₁	0.61*	0.86	1.07	1.07*	1.23	1.39	1.78	---	---
N ₁	0.20	0.24	0.31	0.31	0.31	0.39	0.47	---	---
VB D₉	9	11	14	19	19	24	28	38	42
L ₈	0.79	0.91	1.18	1.57	1.57	1.97	2.36	3.15	3.94
M ₈	1.69	2.17	2.56	3.03	3.31	4.19	5.71	6.54	7.68
M ₉	0.40	0.49	0.63	0.89	0.89	1.06	1.22	1.61	1.77
N ₉	0.12	0.16	0.20	0.24	0.24	0.31	0.31	1.50	1.65
V₈	M4x10	M4x10	M6x15	M8x20	M8x20	M8x20	M8x20	M10x22	M12x25

- D_{5 (r1)} = Diameter on demand

* = Undersized key

- Not binding dimensions, for reference only

- Dimensions are inch / mm

Worm Gears RT

DIMENSIONS

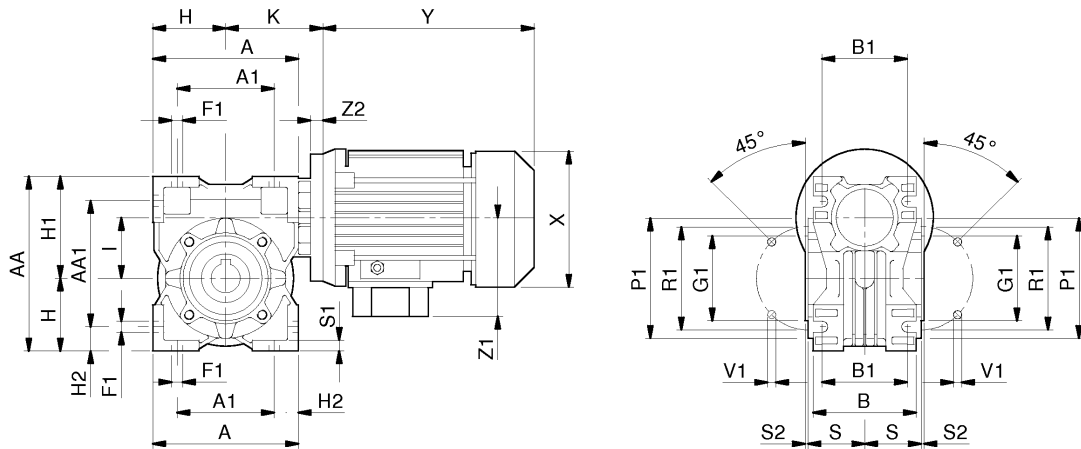

B3

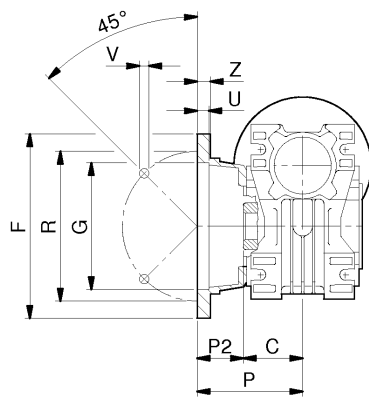
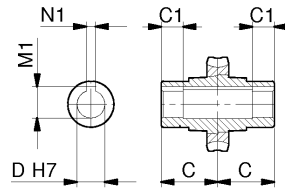

F

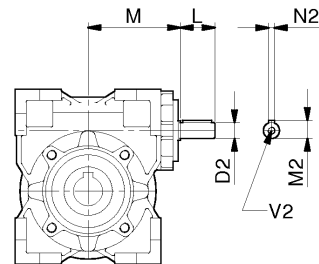

RT

Worm Gears RT

DIMENSIONS

RT	28	40	50	60	70	85	110
A	3.15	3.94	4.72	5.67	6.77	8.11	10.04
A ₁	2.13	2.76	3.15	3.94	4.72	5.51	6.69
AA	3.82	4.78	5.67	6.85	8.07	9.37	11.61
AA ₁	2.80	3.60	4.09	5.12	6.02	6.77	8.27
B	2.09	2.80	3.35	3.94	4.41	5.12	5.67
B ₁	1.73	2.36	2.76	3.35	3.54	3.94	4.53
C	1.18	1.61	1.93	2.36	2.36	2.40	3.05
D _(H7)	0.625	0.75	1.0	1.125	1.25	1.375	1.625
D_(H7)	14	19 (18)	24 (25)	25	28 (30)	32 (35)	42
D_{2 (h6)}	9	11	14	19	19	24	28
F	3.15	4.33	4.92	7.09	7.87	8.27	10.63
F ₁	0.28	0.28	0.35	0.35	0.43	0.51	0.59
G _(H8)	1.97	2.36	2.76	4.53	5.12	5.98	6.69
G _{1 (h8)}	2.17	2.36	2.76	3.15	3.74	4.33	5.12
H	1.57	1.97	2.36	2.83	3.39	4.06	5.02
H ₁	2.24	2.81	3.31	4.02	4.69	5.31	6.59
H ₂	0.51	0.59	0.79	0.87	1.02	1.30	1.67
I	1.10	1.57	1.97	2.36	2.76	3.35	4.33
K	2.60	3.27	3.82	4.06	4.96	6.30	5.94
L	0.79	0.91	1.18	1.57	1.57	1.97	2.36
M	1.97	2.56	2.95	3.43	4.33	4.86	5.75
M ₁	0.71	0.84	1.12	1.25	1.37	1.52	1.80
M ₂	0.40	0.49	0.63	0.89	0.89	1.06	1.22
N ₁	0.19	0.19	0.25	0.25	0.25	0.31	0.38
N ₂	0.12	0.16	0.20	0.24	0.24	0.31	0.31
P	2.09	2.72	3.66	3.39	4.37	4.37	5.16
P ₁	2.95	3.39	3.94	4.33	5.12	6.30	7.87
P ₂	0.91	1.10	1.73	0.98	2.01	1.97	2.11
R	2.68	3.43	3.54	5.93	6.50	6.89	9.06
R ₁	2.56	2.95	3.35	3.74	4.53	5.12	6.50
S	1.08	1.52	1.83	2.24	2.24	2.64	2.91
S ₁	0.24	0.28	0.31	0.39	0.43	0.55	0.51
S ₂	0.10	0.10	0.12	0.12	0.12	0.12	0.14
U	0.39	0.16	0.20	0.26	0.47	0.24	0.20
V	0.28	0.35	0.43	0.43	0.51	0.51	0.55
V₁	M6x10 (4x)	M6x8.5 (4x)	M8x10 (4x)	M8x16 (8x)	M8x16 (8x)	M10x18 (8x)	M10x21 (8x)
V₂	M4x10	M4x10	M6x15	M8x20	M8x20	M8x20	M8x20
Z	0.28	0.23	0.39	0.39	0.55	0.63	0.71
Z ₂	0.51	0.51	0.52 - 0.73	0.55 - 0.59	0.61 - 0.69	0.61 - 0.73	0.71-0.79

- V₁ - 90° for RS28

- Motor dimensions (X, Y, Z1) refer to manufacturer's catalogue

- Not binding dimensions, for reference only

- Dimensions are inch / **mm**

Helical Worm Gears TA

DIMENSIONS

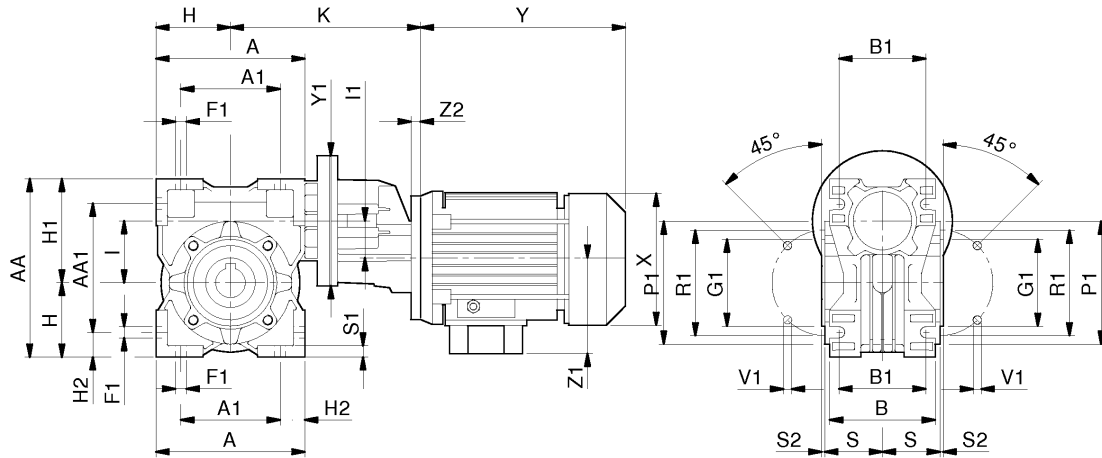

B3

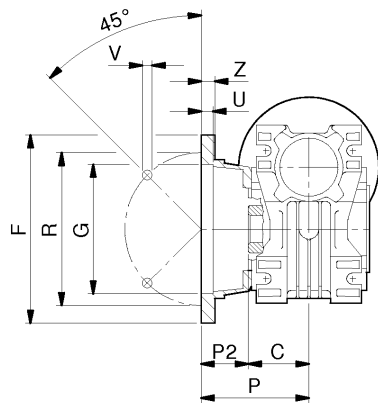
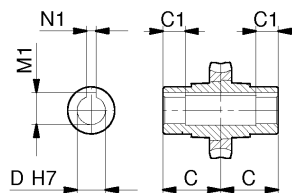

F

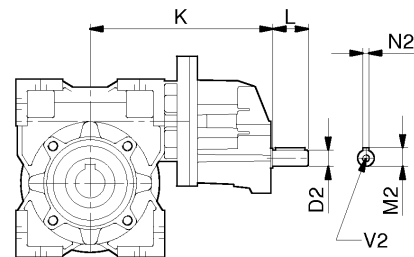

RT

Helical Worm Gears TA

DIMENSIONS

TA	*63 /			*71 /				*80 /				100 /
	40	50	60	50	60	70	85	60	70	85	110	110
A	3.94	4.72	5.67	4.72	5.67	6.77	8.11	5.67	6.77	8.11	10.04	10.04
A ₁	2.76	3.15	3.94	3.15	3.94	4.72	5.51	3.94	4.72	5.51	6.69	6.69
AA	4.78	5.67	6.85	5.67	6.85	8.07	9.37	6.85	8.07	9.37	11.61	11.61
AA ₁	3.60	4.09	5.12	4.09	5.12	6.02	6.77	5.12	6.02	6.77	8.27	8.27
B	2.80	3.35	3.94	3.35	3.94	4.41	5.12	3.94	4.41	5.12	5.67	5.67
B ₁	2.36	2.76	3.35	2.76	3.35	3.54	3.94	3.35	3.54	3.94	4.53	4.53
C	1.61	1.93	2.36	1.93	2.36	2.36	2.40	2.36	2.36	2.40	3.05	3.05
D _(H7)	0.625	1.0	1.125	1.0	1.125	1.25	1.375	1.125	1.25	1.375	1.625	1.625
D _(H7)	19 (18)	24 (25)	25	24 (25)	25	28 (30)	32 (35)	25	28 (30)	32 (35)	42	42
D ₂	11	11	11	14	14	14	14	19	19	19	19	24
F	4.33	4.92	7.09	4.92	7.09	7.87	8.27	7.09	7.87	8.27	10.63	10.63
F ₁	0.28	0.35	0.35	0.35	0.35	0.43	0.51	0.35	0.43	0.51	0.59	0.59
G _(H8)	2.36	2.76	4.53	2.76	4.53	5.12	5.98	4.53	5.12	5.98	6.69	6.69
G ₁	2.36	2.76	3.15	2.76	3.15	3.74	4.33	3.15	3.74	4.33	5.12	5.12
H	1.97	2.36	2.83	2.36	2.83	3.39	4.06	2.83	3.39	4.06	5.02	5.02
H ₁	2.81	3.31	4.02	3.31	4.02	4.69	5.31	4.02	4.69	5.31	6.59	6.59
H ₂	0.59	0.79	0.87	0.79	0.87	1.02	1.30	0.87	1.02	1.30	1.67	1.67
I	1.57	1.97	2.36	1.97	2.36	2.76	3.35	2.36	2.76	3.35	4.33	4.33
I ₁	1.26	1.26	1.26	1.57	1.57	1.57	1.57	1.97	1.97	1.97	1.97	1.97
K	6.04	6.73	6.97	6.81	7.20	8.23	8.82	8.15	9.15	9.86	10.41	12.91
L	0.91	0.91	0.91	1.18	1.18	1.18	1.18	1.57	1.57	1.57	1.57	1.97
M ₁	0.71	1.12	1.25	1.12	1.25	1.37	1.52	1.25	1.37	1.52	1.80	1.80
M ₂	0.49	0.49	0.49	0.63	0.63	0.63	0.63	0.89	0.89	0.89	0.89	1.06
N ₁	0.19	0.25	0.25	0.25	0.25	0.25	0.31	0.25	0.25	0.31	0.38	0.38
N ₂	0.16	0.16	0.16	0.20	0.20	0.20	0.20	0.24	0.24	0.24	0.24	0.31
P	2.72	3.66	3.39	3.66	3.39	4.37	4.37	3.39	4.37	4.37	5.16	5.16
P ₁	3.39	3.94	4.33	3.94	4.33	5.12	6.30	4.33	5.12	6.30	7.87	7.87
P ₂	1.10	1.73	0.98	1.73	0.98	2.01	1.97	0.98	2.01	1.97	2.11	2.11
R	3.43	3.54	5.93	3.54	5.93	6.50	6.89	5.93	6.50	6.89	9.06	9.06
R ₁	2.95	3.35	3.74	3.35	3.74	4.53	5.12	3.74	4.53	5.12	6.50	6.50
S	1.52	1.83	2.24	1.83	2.24	2.24	2.64	2.24	2.24	2.64	2.91	2.91
S ₁	0.28	0.31	0.39	0.31	0.39	0.43	0.55	0.39	0.43	0.55	0.51	0.51
S ₂	0.10	0.12	0.12	0.12	0.12	0.12	0.12	0.12	0.12	0.12	0.14	0.14
U	0.16	0.20	0.26	0.20	0.26	0.47	0.24	0.26	0.47	0.24	0.20	0.20
V	0.35	0.43	0.43	0.43	0.43	0.51	0.51	0.43	0.51	0.51	0.55	0.55
V ₁	M6x8 (4)	M8x10 (4)	M8x16 (8)	M8x10 (4)	M8x16 (8)	M8x16 (8)	M10x18 (8)	M8x16 (8)	M8x16 (8)	M10x18 (8)	M10x21 (8)	M10x21 (8)
V ₃	M4 x 10	M4 x 10	M4 x 10	M6 x 15	M6 x 15	M6 x 15	M6 x 15	M8 x 20	M8 x 20	M8 x 20	M8 x 20	M8 x 20
Y ₁	4.13	4.13	4.13	4.72	4.72	4.72	4.72	5.51	5.51	5.51	5.51	5.51
Z	0.24	0.39	0.39	0.39	0.39	0.55	0.63	0.39	0.55	0.63	0.71	0.71
Z ₂	0.51	0.51	0.51	0.51	0.51	0.51	0.51	0.55	0.55	0.55	0.55	0.55

- V₁ - 90° for RS28

- Motor dimensions (X, Y, Z₁) refer to manufacturer's catalogue

- * IEC input only

- Not binding dimensions, for reference only

- Dimensions are inch / mm

Double Worm Gears RT

DIMENSIONS

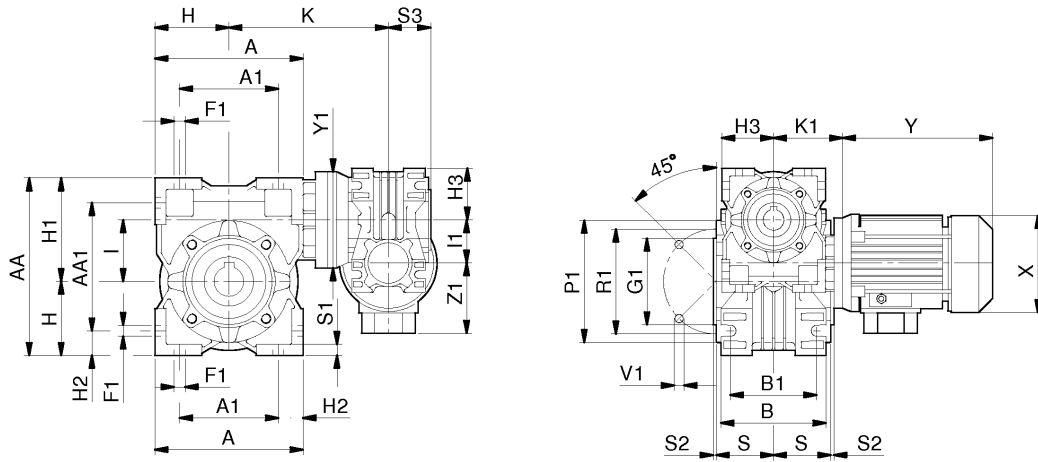

B3

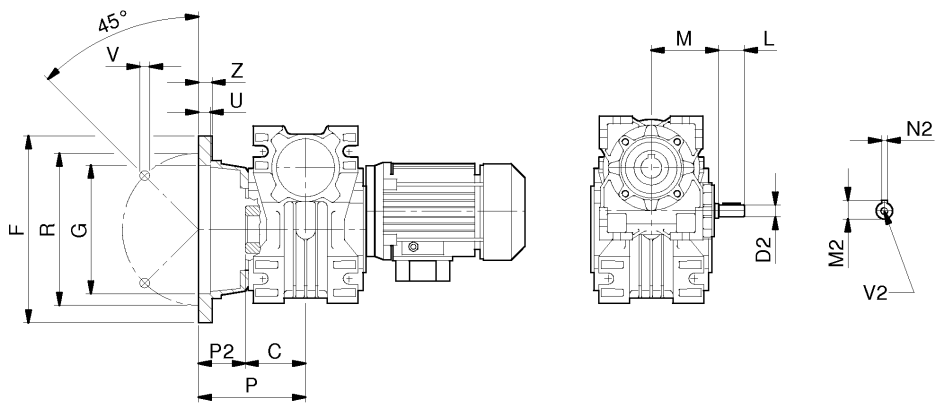
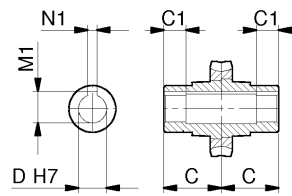

F

RT

Double Worm Gears RT

DIMENSIONS

RT	28 /				40 /		50 /
	28	40	50	60	70	85	110
A	3.15	3.94	4.72	5.67	6.77	8.11	10.04
A ₁	2.13	2.76	3.15	3.94	4.72	5.51	6.69
AA	3.82	4.78	5.67	6.85	8.07	9.37	11.61
AA ₁	2.80	3.60	4.09	5.12	6.02	6.77	8.27
B	2.09	2.80	3.35	3.94	4.41	5.12	5.67
B ₁	1.73	2.36	2.76	3.35	3.54	3.94	4.53
C	1.18	1.61	1.93	2.36	2.36	2.40	3.05
D ^(H7)	0.625	0.75	1.0	1.125	1.25	1.375	1.625
D^(H7)	14	19 (18)	24 (25)	25	28 (30)	32 (35)	42
D₂^(h6)	9	9	9	9	11	11	14
F	3.15	4.33	4.92	7.09	7.87	8.27	10.63
F ₁	0.28	0.28	0.35	0.35	0.43	0.51	0.59
G ^(H8)	1.97	2.36	2.76	4.53	5.12	5.98	6.69
G ₁ ^(h8)	2.17	2.36	2.76	3.15	3.74	4.33	5.12
H	1.57	1.97	2.36	2.83	3.39	4.06	5.02
H ₁	2.24	2.81	3.31	4.02	4.69	5.31	6.59
H ₂	0.51	0.59	0.79	0.87	1.02	1.30	1.67
H ₃	1.57	1.57	1.57	1.57	1.97	1.97	2.36
I	1.10	1.57	1.97	2.36	2.76	3.35	4.33
I ₁	1.10	1.10	1.10	1.10	1.57	1.57	1.97
K	3.13	3.92	5.55	5.73	5.65	7.83	7.99
K ₁	2.26	2.26	2.26	2.26	2.78	2.78	3.27
L	0.79	0.79	0.79	0.79	0.91	0.91	1.18
M	1.97	1.97	1.97	1.97	2.56	2.56	2.95
M ₁	0.71	0.84	1.12	1.25	1.37	1.52	1.80
M ₂	0.40	0.40	0.40	0.40	0.49	0.49	0.63
N ₁	0.20	0.24	0.31	0.31	0.31	0.39	0.47
N ₂	0.12	0.12	0.12	0.12	0.16	0.16	0.20
P	2.09	2.72	3.66	3.39	4.37	4.37	5.16
P ₁	2.95	3.39	3.94	4.33	5.12	6.30	7.87
P ₂	0.91	1.10	1.73	0.98	2.01	1.97	2.11
R	2.68	3.43	3.54	5.93	6.50	6.89	9.06
R ₁	2.56	2.95	3.35	3.74	4.53	5.12	6.50
S	1.08	1.52	1.83	2.24	2.24	2.64	2.91
S ₁	0.24	0.28	0.31	0.39	0.43	0.55	0.51
S ₂	0.10	0.10	0.12	0.12	0.12	0.12	0.14
S ₃	1.18	1.18	1.18	1.18	1.61	1.61	1.93
U	0.39	0.16	0.20	0.26	0.47	0.24	0.20
V	0.28	0.35	0.43	0.43	0.51	0.51	0.55
V₁	M6x10 (4x)	M6x8,5 (4x)	M8x10 (4x)	M8x16 (8x)	M8x16 (8x)	M10x18 (8x)	M10x21 (8x)
V₂	M4x10	M4x10	M4x10	M4x10	M4x10	M4x10	M6x15
Y ₁	3.15	3.54	3.54	3.54	4.72	4.72	4.72
Z	0.28	0.24	0.39	0.39	0.55	0.63	0.71

- V₁ - 90° for RT28

- Not binding dimensions, for reference only

- Dimensions are inch / mm

Worm Gears RT

DIMENSIONS

ACCESSORIES

AS
Solid single
output shaft

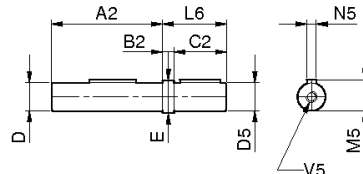

AD
Solid double
output shaft

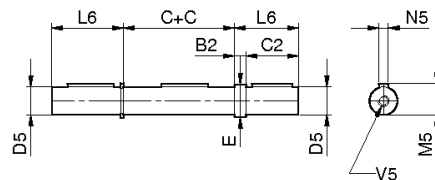

ASC
Safety cap for AS

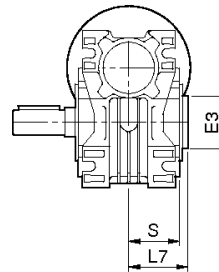

BT
Torque arm

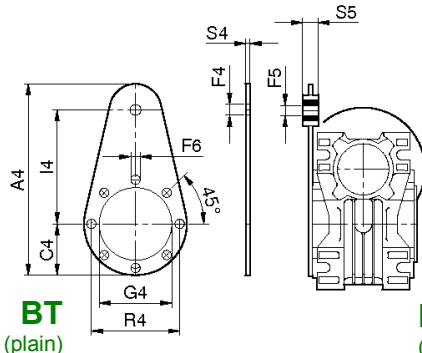

BT
(plain)

BTV
(Vulkollan)

SL
Speed Limiter

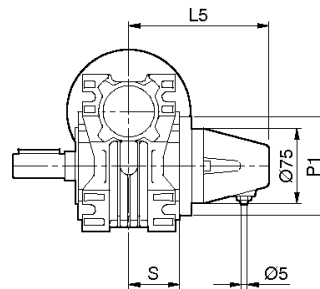

TL
Torque Limiter

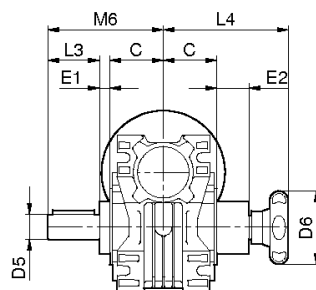

TLE (external)

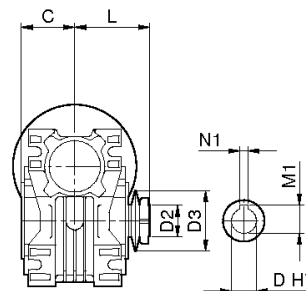

TLI (internal)

VB
NDE wormshaft
extension

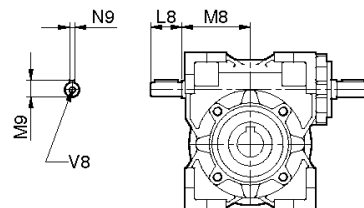

TLI **LUBRICATION**

Size	US qt	litres
28	0.04	0.04
40	0.10	0.10
50	0.14	0.13
60	0.31	0.30
70	0.48	0.45
85	0.79	0.75
110	2.38	2.25

Worm Gears RT

ACCESSORIES	DIMENSIONS						
RT	28	40	50	60	70	85	110
AS & AD A ₂	2.28	3.16	3.74	4.61	4.61	4.69	6.02
B ₂	0.08	0.39	0.39	0.39	0.39	0.39	0.39
C	1.18	1.61	1.93	2.36	2.36	2.40	3.05
C ₂	1.375	1.57	1.97	2.36	2.36	2.76	3.15
D _{5 (g6)}	0.625	0.75	1.0	1.125	1.25	1.375	1.625
D_{5 (g6)}	14	19 (18)	24 (25)	25	28 (30)	32 (35)	42
E	0.82	0.98	1.25	1.37	1.49	1.69	1.95
L ₆	1.42	1.97	2.37	2.76	2.76	3.15	3.54
M ₅	0.70	0.83	1.10	1.23	1.36	1.51	1.79
N ₅ x N ₅	3/16	3/16	1/4	1/4	1/4	5/16	3/8
V ₅	1/4"-20	1/4"-20	3/8"-16	3/8"-16	1/2"-13	1/2"-13	5/8"-11
ASC E ₃	1.97	2.05	2.44	2.95	3.54	3.94	4.72
L ₇	1.42	1.91	2.19	2.70	2.64	3.03	3.35
S	1.08	1.52	1.83	2.24	2.24	2.64	2.91
BT & BTV A ₄	5.43	6.61	7.28	9.25	11.61	12.32	15.28
C ₄	1.50	1.69	2.36	2.17	2.56	2.95	3.94
F ₄	0.41	0.41	0.41	0.41	0.41	0.81	0.81
F ₅	0.39	0.39	0.39	0.39	0.39	0.79	0.79
F ₆	0.28	0.28	0.35	0.35	0.35	0.47	0.51
G ₄	2.17	2.36	2.76	3.15	3.74	4.33	5.12
I ₄	3.15	3.94	3.94	5.91	7.87	7.87	9.84
R ₄	2.56	2.95	3.35	3.74	4.53	5.12	6.50
S ₄	0.16	0.16	0.16	0.24	0.24	0.24	0.24
S ₅	0.59	0.59	0.59	0.79	0.79	0.98	0.98
SL L ₅	3.78	4.45	4.84	5.24	5.24	5.47	5.91
P ₁	3.07	3.54	3.94	4.33	5.12	6.30	7.87
S	1.08	1.52	1.83	2.24	2.24	2.64	2.91
TLE D ₆	2.05	2.76	2.76	2.76	3.15	3.94	3.94
E ₁	0.39	0.47	0.47	0.59	0.55	0.75	0.94
E ₂	1.10	1.46	1.22	1.57	1.81	2.24	2.80
L ₃	1.18	1.57	1.97	1.97	2.36	2.76	3.15
L ₄	3.70	4.57	4.65	5.04	5.75	6.61	7.91
M ₆	2.76	3.66	4.37	4.92	5.28	5.91	7.13
TLI D _(H7)	14	18	24	25	28	32	42
D ₂	1.57	2.20	2.80	2.80	3.15	3.54	4.92
D ₃	0.56x0.79	0.77x0.81	0.96x1.10	1.00x1.02	1.12x0.87	1.28x1.06	1.67x1.52
L	1.77	2.42	3.03	3.41	3.50	3.70	4.43
M ₁	0.61*	0.86	1.07	1.07*	1.23	1.39	1.78
N _{1 (H9)}	0.20	0.24	0.31	0.31	0.31	0.39	0.47
VB D ₉	9	11	14	19	19	24	28
L ₈	0.79	0.91	1.18	1.57	1.57	1.97	2.36
M ₈	1.69	2.17	2.56	3.03	3.31	4.19	5.71
M ₉	0.40	0.49	0.63	0.89	0.89	1.06	1.22
N ₉	0.12	0.16	0.20	0.24	0.24	0.31	0.31
V₈	M4x10	M4x10	M6x15	M8x20	M8x20	M8x20	M8x20

- D_{5 (,,)} = Diameter on demand
 * = Undersized key
 - Not binding dimensions, for reference only - Dimensions are inch / mm

Worm Gears RS-RT

Helical Single-Stage Attachment - XA

DIMENSIONS AND WEIGHTS

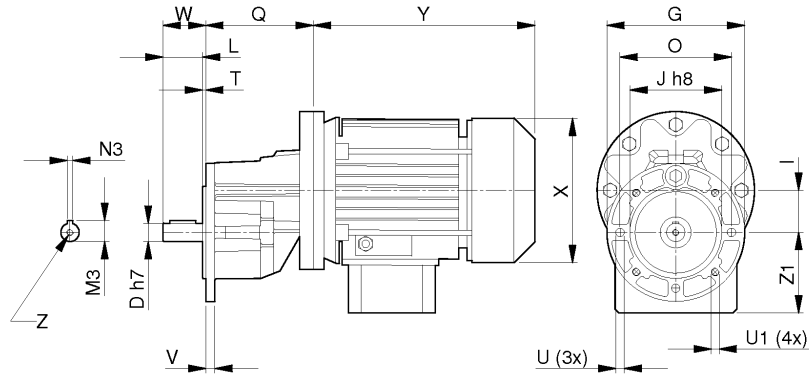

XA dims	D _{h7} [mm]	G [mm]	I	J _{h8} [mm]	L	O [mm]	Q	U	U1	T	V	W	Z
(*) 63	14	105	1.26	70	1.18	85	3.27	0.26	M6	0.10	0.28	1.28	M5x10
(*) 71	19	120	1.57	80	1.57	100	3.54	0.22	M6	0.10	0.30	1.67	M8x20
(*) 80	24	140	1.97	95	1.95	115	4.49	0.35	M6	0.10	0.41	2.05	M8x20
100	28	200	2.48	130	2.26	165	6.97	0.41	0.41	0.10	0.47	2.36	M10x22

(*) - IEC input only

XA wts	lb	US qt	litres
63	2.23	0.04	0.04
71	4.28	0.06	0.06
80	6.36	0.11	0.10
100	15.25	0.21	0.20

- Motor dimensions (X, Y, Z1) refer to manufacturer's catalogue
 - Not binding dimensions, for reference only
 - Dimensions are inch / **mm**

Worm Gears RS-RT

BACK-DRIVING - SELF-LOCKING - GEARING DATA

When back-driving a worm gear set using the worm wheel as input, the efficiency is lower than forward-driving and, by varying the design data, back-drive efficiency can be reduced to zero obtaining a self-locking, or irreversible, gear set.

When back-driving the worm gear, internal friction tends to lock the mesh, and the bigger the applied torque the mesh friction increases proportionally augmenting the lockage at the same time.

The most obvious example is during braking or slowing-down where the inertial load will try to back-drive the worm shaft.

A worm gear is intended as static self-locking drive when the lead angle (β) is lower than the friction angle (arc tangent of friction coefficient).

Tooth contact can be dynamic even when the mesh velocity is zero, as vibrations in a non-rotating gear set can induce motion in the tooth contact.

To provide a safety factor, lead angles smaller than 3 degrees are recommended for full self-locking condition, and lead angles bigger than 10 degrees for full reversibility condition, according to the below cross-table between lead angles and self-locking.

Lead angle	Static self-locking & Reversibility
$\beta > 20^\circ$	Full reversibility
$10^\circ < \beta < 20^\circ$	High reversibility
$5^\circ < \beta < 10^\circ$	Good reversibility Poor static self-locking
$3^\circ < \beta < 5^\circ$	Poor reversibility Good static self-locking
$1^\circ < \beta < 3^\circ$	Full static self-locking

Examples (β lead angle from the table below):





- FRT50 1/7 $\beta = 23^\circ 52'$ → Full reversibility
- FRS60 1/20 $\beta = 11^\circ 18'$ → High reversibility
- FRT85 1/56 $\beta = 4^\circ 45'$ → Good reversibility
 Poor static self-locking
- FRT40 1/56 $\beta = 3^\circ 25'$ → Poor reversibility/
 Good static self-locking
- FRT70 1/80 $\beta = 2^\circ 51'$ → Full static self-locking

Size	Ratio $i =$	5	7	10	15	20	28	40	49	56	70	80	100
RS/RT 28	β	---	23°14'	16°41'	11°18'	10°23'	6°06'	5°14'	4°19'	3°03'	2°27'	2°37'	2°20'
RS/RT 40	β	30°57'	21°36'	16°41'	11°18'	8°31'	5°39'	4°17'	3°48'	3°25'	3°01'	2°51'	2°38'
RS/RT 50	β	30°57'	23°52'	16°41'	11°18'	8°59'	6°19'	4°31'	4°14'	3°42'	2°44'	2°51'	2°17'
RS/RT 60	β	36°32'	25°33'	19°0'	12°55'	11°18'	6°49'	5°42'	5°11'	3°55'	3°38'	2°51'	2°51'
RS/RT 70	β	34°01'	26°51'	18°38'	12°40'	11°18'	7°12'	5°42'	4°48'	4°05'	3°16'	2°51'	2°38'
RS/RT 85	β	34°47'	26°05'	19°09'	13°02'	11°18'	6°58'	5°52'	4°52'	4°45'	3°48'	3°14'	2°40'
RS/RT 110	β	---	26°22'	20°43'	14°09'	11°18'	7°04'	5°42'	4°43'	4°29'	3°54'	3°39'	2°34'
RS 130	β	---	26°57'	21°20'	14°06'	13°05'	7°14'	6°18'	5°18'	6°20'	4°33'	3°30'	3°40'
RS 150	β	---	25°33'	21°48'	16°22'	13°24'	7°35'	7°07'	5°48'	6°11'	4°17'	3°45'	3°43'

$\beta =$ Lead angle

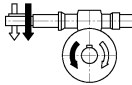
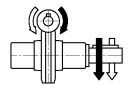
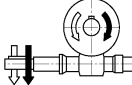
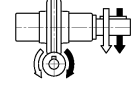
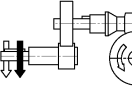
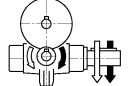
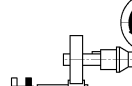
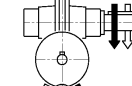
Worm Gears RS-RT

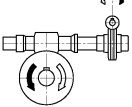
DIRECTION OF ROTATION

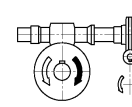
Wormshaft upwards		Wormshaft downwards
 	RS RT	 
 	RA TA	 
 	RS / RS RT / RT	 

Abstract of Operation and Maintenance Instructions (download complete manual from www.varvel.com)

Variators and reduction gearboxes are not part of application field of article 1(2) Machinery Directive and they must not be put into service until the machinery into which they are to be incorporated, has been declared in conformity with the provision of article 4(2), annex II(B) of Machinery Directive 2006/42/EC.

Installation

Check the unit to be installed is properly selected to perform the required function and its mounting position complies with the order.

The nameplate reports such information.

Check mounting stability to ensure the unit runs without vibrations or overloads.

Running

The unit may be connected for clockwise or counter-clockwise rotation.

The unit must be stopped as soon as defective running or unexpected noise occur, remove the faulty part or return the unit to the factory for inspection.

If the faulty part is not replaced, other parts can also be affected, causing more severe damage and making the identification of initial cause more difficult.

Maintenance

Although the units are no-load run tested in the factory before despatch, it is recommended not to run them at maximum load for the first 20-30 operation hours to allow the proper running in.

The gearboxes are delivered already filled with long-life synthetic oil and, in case of replacement or topping, do not mix with mineral lubricants.

Handling

When hoisting, use relevant housing locations or eyebolts if provided, or foot or flange holes.

Never hoist on any moving part.

Painting

Carefully protect oil seals, coupling faces and shafts when units are re-painted.

Long-term storage

For storage longer than three months, apply antioxidants onto shafts and machined surfaces, and protective grease on oil seal lips.

Product's Environmental Management

In conformity with ISO 14001 Environmental Certification, we recommend the following to dispose of our products:

- scraped components of the units to be delivered to authorized centres for metal object collection;
- oils and lubricants drained from the units to be delivered to Exhausted Oil Unions;
- packages (pallets, carton boxes, paper, plastic, etc.) to lead into regeneration/recycling circuits as far as possible, by delivering separate waste classes to authorized companies.

Directive 94/9/EC - ATEX

Directive involves either electrical machines and every apparatus and control devices to be used in potentially explosive atmosphere, to be installed within the European Community Territory.

VARVEL products specially asked for ATEX are manufactured according to Directive 1994/9/EC and they are qualified for installation in potentially explosive environment.

To the scope of intensifying our commitment to society, Varvel since 2004 started an ongoing support programme with three non-profit institutions: UNICEF (United Nations Children's Fund), MSF (Médecins sans Frontières) and ANT (National Cancer Association). Environmental respect and protection are also part of Varvel's values and this is why Varvel certified in 2001 its Environmental System to standard UNI EN ISO 14001.



A socially responsible company



Une entreprise socialement responsable

Pour renforcer son investissement dans la société depuis 2004 Varvel a entrepris un programme de soutien constant auprès de 3 associations ONG: UNICEF (Fonds des Nations unies pour l'enfance), MSF (médecins sans frontière) et ANT (Association Italienne contre les tumeurs). Le respect et la tutelle de l'environnement font également partie des nos valeurs pour cela depuis 2001 Varvel ha obtenu la certification du système de management environnemental suivant la norme UNI EN ISO 14001.

Una empresa socialmente responsable

Para reforzar su compromiso con la sociedad, desde el 2004 Varvel ha iniciado un programa de ayuda continuada a 3 asociaciones sin ánimo de lucro.: UNICEF (Fondo de las Naciones Unidas para la Infancia), MSF (Médicos sin Fronteras) y ANT (Asociación contra el Cáncer). También el respeto y cuidado del ambiente forman parte de los valores Varvel y por ello desde el 2001 Varvel ha certificado el Sistema Ambiental según la normativa UNI EN ISO 14001.

Other catalogues



RN/RO/RV



RD



RG



RP



VR/VS

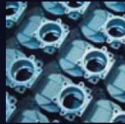

VARVEL[®]

MOTION CONTROL SINCE 1955

Available from:

DIEQUA
Corporation

180 Covington Drive
Bloomington, IL 60108-3105
Phone: 630-980-1133
Email: info@diequa.com
Web: www.diequa.com