

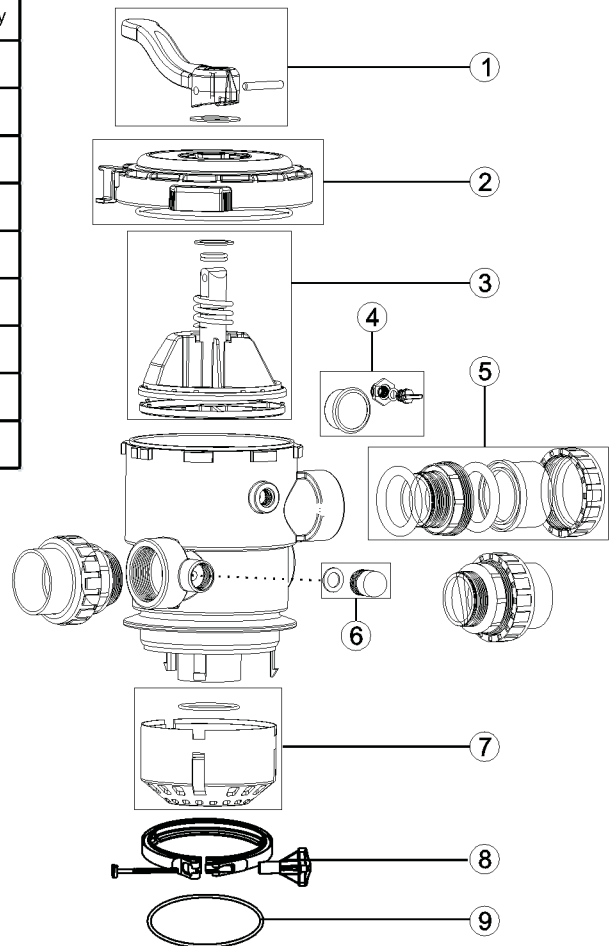

6-Way 2.0" Clamp Type Multiport Valve for LSFII-25-50, LSFII-28-50

PARTS OF VALVE

Key No.	Part No.	Product Description	Qty
1	89280702	MPV Handle Assembly	1
2	89280809	Lid Assembly 2" MPV	1
3	89280810	Seal Rotor and Gasket Kit 2" MPV	1
4	89280705	Pressure gauge Assembly	1
5	89280110	2" UNION	3
6	89280104	Sight glass assembly	1
7	89280811	Diffuser Assembly 2"	1
8	89010126	Stainless Steel Clamp Assembly	1
9	02011134	O-Ring for Filter Neck	1



WARNING

- TURN PUMP OFF BEFORE CHANGING VALVE POSITION.
- THIS FILTER OPERATES UNDER HIGH PRESSURE. WHEN ANY PART OF THE CIRCULATING SYSTEM (e.g., CLAMP, PUMP, FILTER, VALVES, ETC.) IS SERVICED, AIR CAN ENTER THE SYSTEM AND BECOME PRESSURIZED. PRESSURIZED AIR CAN CAUSE THE LID OR VALVE TO BE BLOWN OFF WHICH CAN RESULT IN SEVERE INJURY, DEATH, OR PROPERTY DAMAGE
- TO PREVENT DAMAGE TO THE PUMP AND FOR PROPER OPERATION OF THE SYSTEM, CLEAN PUMP STRAINER AND SKIMMER BASKETS REGULARLY.



onga

Pentair Water

FUNCTIONS OF VALVE POSITIONS

Valve Position	Function
FILTER	Normal Filtration
BACKWASH	Cleaning Filter by reversing the flow
RINSE	Used after backwash to flush dirt from valve
WASTE	By-passes filter, used for vacuuming to waste or lowering water level
RECIRCULATE	By-passes filter for circulating water to pool
CLOSED	Shuts off all flow to filter or pool

FILTER

WASTE

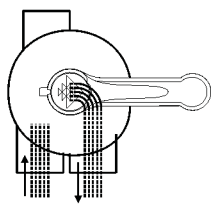

IN FLOW OUT FLOW

WASTE

WASTE

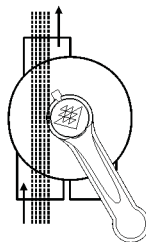

IN FLOW OUT FLOW

CLOSED

WASTE

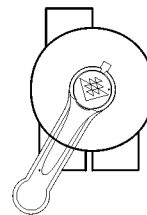

IN FLOW OUT FLOW

BACKWASH

WASTE

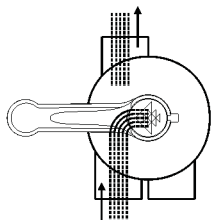

IN FLOW OUT FLOW

RINSE

WASTE

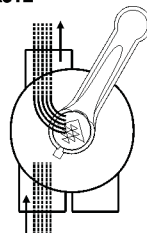

IN FLOW OUT FLOW

RECIRCULATE

WASTE

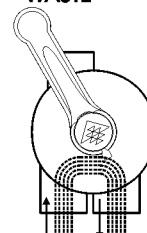

IN FLOW OUT FLOW

GENERAL

1. Pipe tap boss provided for optional influent pressure gauge.
2. SERVICING VALVE(Stop pump,close gate valve in suction&discharge before proceeding):
 - a. Set handle in filter position.
 - b. Remove cover screws.
 - c. Lift cover and key assembly out.

TO ASSEMBLE:

- d. Place valve key so that wedge opening is at TOP port (handle in Filter psn.). Flat edge of cover screw lug should align with flat edge of body screw lug.
- e. Position cover O'Ring.
- f. Secure assembly to body with cover screws. Tighten cover screws evenly and alternately. Do not over-tighten.