



Hose & Pipe

Ford

Direct Replacement

AL6400

Falcon BA
All assembly



AL6401

Falcon BA
Liquid line all

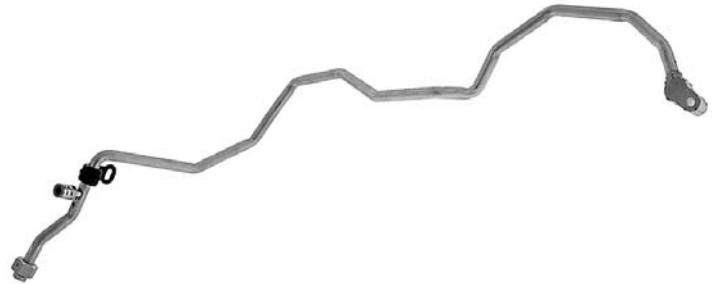

HO0144

Falcon BA
Discharge 6 cyl
BRZ3 19C700 44



HO0145

Falcon BA
Discharge V8
3R23-19C700-BA



HO0146

Falcon BA
Suction 6 cyl
3R23-19997-AA



HO0155

Falcon AU 6 cyl
ER 1908504



Direct Replacement

Ford

HO0133

Falcon EF

6 cyl, Assembly
Genuine # EF 19D85OE



HO0201

Falcon EB

6 cyl, Liquid line
Genuine # ED 19B881C

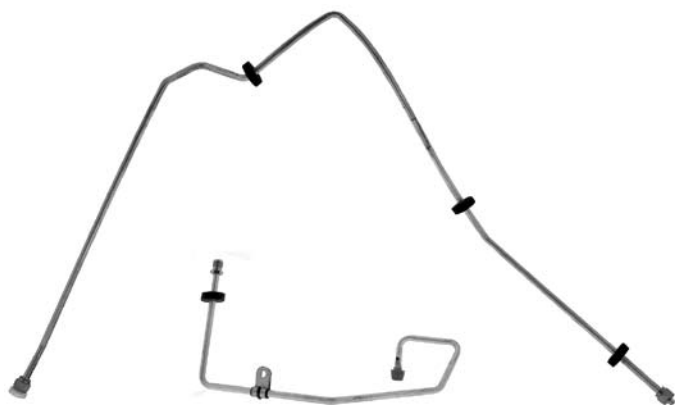

HO0110

Falcon EB

6 cyl, Suction R134a



HO6451

Falcon EA

6 Cyl, Discharge MPI
Genuine # EA 19972A



HO0125

Falcon XF

All discharge
Genuine # XFL 19972A

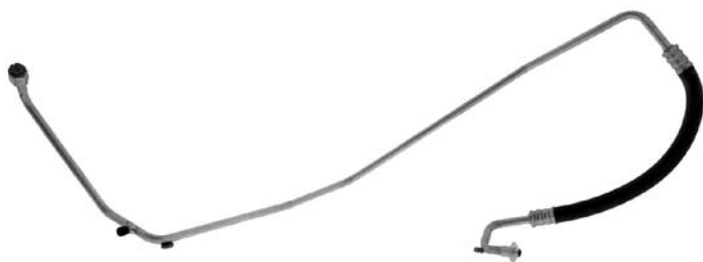

HO0123

Falcon XE

6 cyl, Discharge
Genuine # XE 19972C



Hose & Pipe

Ford

Direct Replacement

HO0119

Falcon XD, XE
8 cyl, Discharge
XD19972B



AL2015

Festiva WB
CN-FDR Liquid pipe



HO4870

Festiva WB
Suction

1/94>

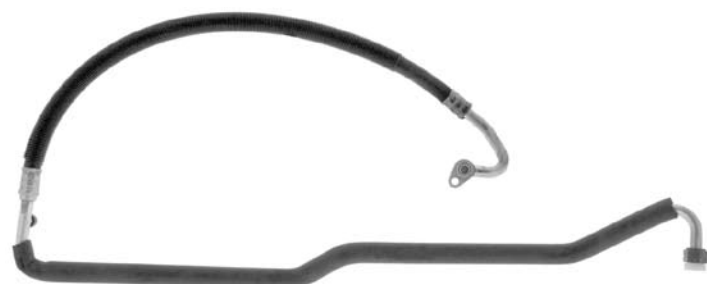

HO4871

Festiva WB
Discharge

1/94>



HO5795

Laser KF, KH
Discharge R12 only



AL5390

Laser KN 4 Door
Liquid line
MAC 0855861

03/99



Direct Replacement

Holden

HO0116

Apollo JK, JL

Discharge
Genuine # 24612-01990

8/89 - 3/93



HO0117

Apollo JK, JL

Suction
Genuine # 24614-03520

8/89 - 3/93



HO6553

Astra LD

Discharge
Genuine # VS18529

7/87 - 7/89



HO6181

Barina MF, MH

Discharge
Genuine # VS19554

1/89 - 3/94

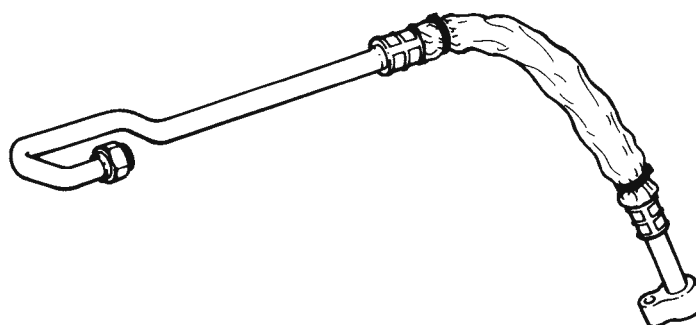

AL2018

Barina SB

Liquid FDR



AL5545

Commodore VE

Suction



Holden

Direct Replacement

HO2037

Commodore VE V6
Hose assembly



HO5546

Commodore VE V6
Liquid Pipe



HO2038

Commodore VE V8
Hose assembly

Picture unavailable at time of print

HO8260

Commodore VY V6
Hose assembly



AL6318

Commodore VT, VY
6 cyl & V8
Liquid Pipe FDR/Evaporator

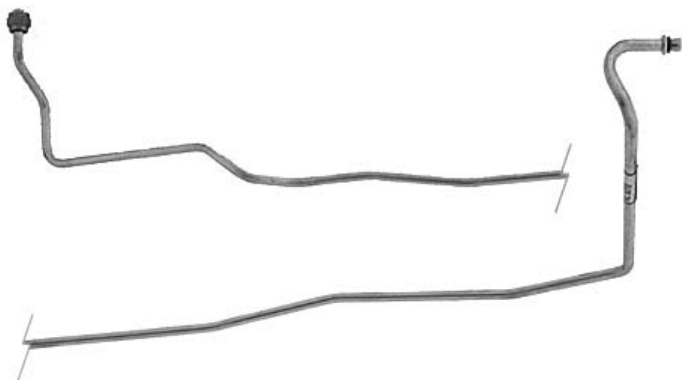

AL6319

**Commodore VT, VX (6&8cyl),
Statesman WH (6&8cyl), Statesman VU Ute (6&8cyl),
Monaro V2C from L924425**
5/16" Liquid pipe FDR/Evaporator



Direct Replacement

Holden

HO8253A

Commodore VT, VX
Hose assembly
Without transducer

9/97 - 8/00



HO8253

Commodore VT, VX
6 cyl
With transducer

9/97 - 8/00



HO8254

Commodore VT
V8

9/97 - 8/00

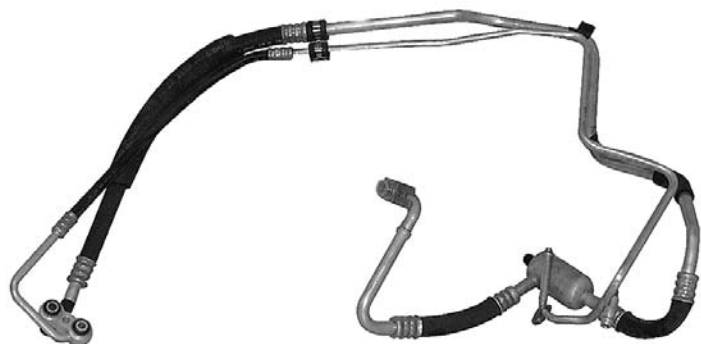

AL6315

Commodore VR, VS
V6 & V8, Discharge
Liquid Pipe (set of 2 replaces original (1) piece)

7/93 - 8/97

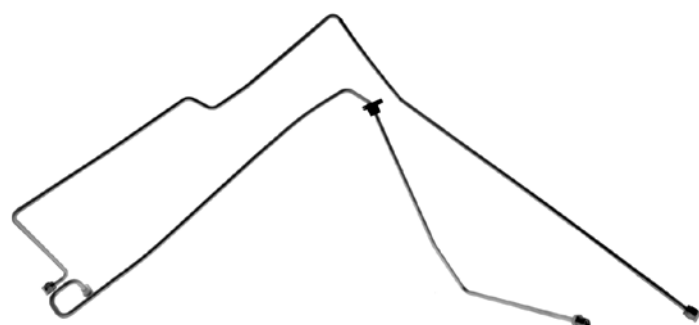

HO8251

Commodore VR, VS
6 cyl, Discharge
Genuine # 92042036

7/93 - 8/97



HO8256

Commodore VR, VS V8
Discharge



Hose & Pipe

Holden

Direct Replacement

HO8252

Commodore VR
6 cyl, Suction



HO0437

Commodore VN, VP
6 cyl, Suction

8/88 - 6/93



HO0868

Commodore VN, VQ
6 cyl, Discharge
Genuine # 92037511

8/88 - 6/93



HO4680

Commodore VL
6 cyl, Suction
Genuine # 92024026

1/86 - 7/88



HO4681

Commodore VL
6 cyl, Discharge

1/86 - 7/88



HO4563

Commodore VK
6 cyl, Suction



Direct Replacement

Holden

HO4565

Commodore VK
6 cyl, Discharge
Genuine # 92023224



AL6318

Monaro V2C
6 cyl & V8
from L924425

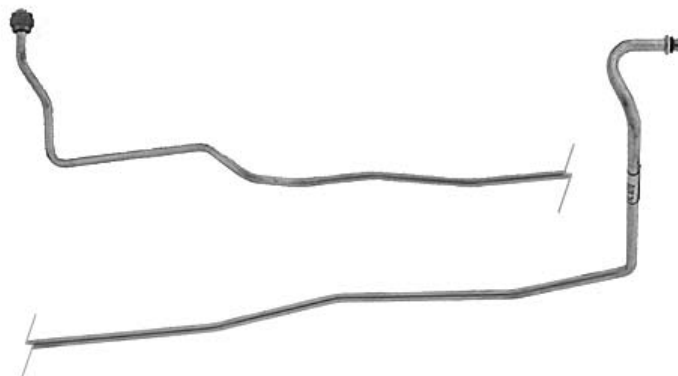

HO8036

Rodeo TF Turbo Diesel
Discharge



HO8037

Rodeo TF Turbo Diesel
Suction

Picture unavailable at time of print

HO0437

Statesman VQ **3/90 - 5/99**
6 cyl, Suction



AL6318

Statesman WK
6 cyl & V8
Liquid Pipe FDR/Evaporator

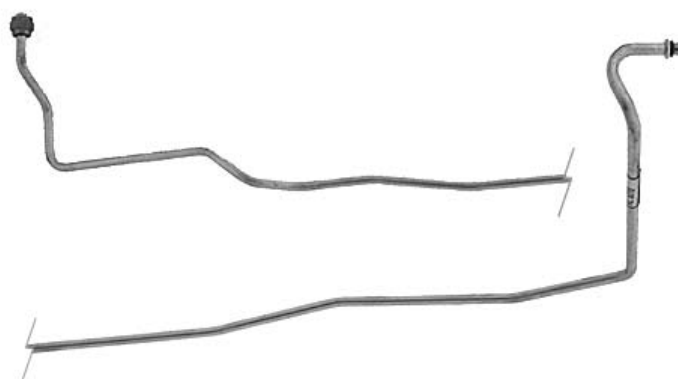

Hose & Pipe

Holden

Direct Replacement

HO0437

Statesman VQ
6 cyl, Suction

3/90 - 5/99

HO0868

VG Ute
6 cyl, Discharge
Genuine # 92037511

8/90 >



Direct Replacement

Hyundai

AL2099

Excel X2
Pipe Set



AL2004

Excel X3
Cond-FDR

95 > 97



HO0175

Excel X3
Discharge hose from compressor

95 - 97

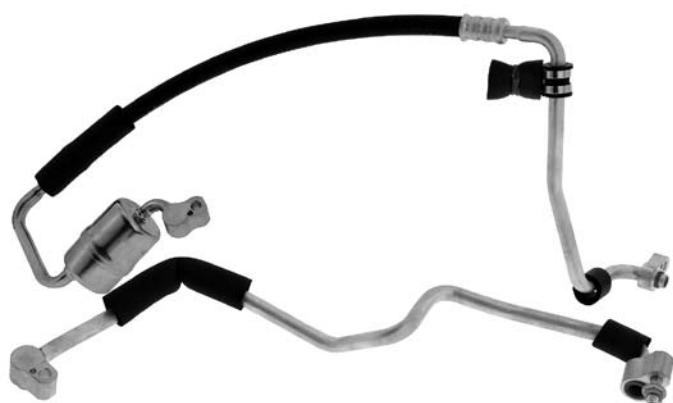

HO0175A

Excel X3
Discharge

95 - 97



HO0176

Excel X4
Suction

95 - 97



AL2012

Lantra
Liquid pipe

94 - 95

Picture unavailable at time of print

Hyundai

Direct Replacement

AL5088

Lantra
Condenser to FDR



HO0138

Lantra **94 - 95**
Suction



HO0139

Lantra **94 - 95**
Discharge, Complete with muffler



HO0142

Sonata **94 - 95**
Discharge, Complete with muffler



Direct Replacement

Mazda/Mercedes

AL0627

121DW
Cond-FDR



AL0477

121
Cond-FDR Liquid pipe



AL0860

MX5 w/ABS
Pipe



HO0485

T Series WH
Liquid



AL2030

M Class



Mitsubishi

Direct Replacement

HO7604

Galant HG
Discharge

6/90 - 11/92

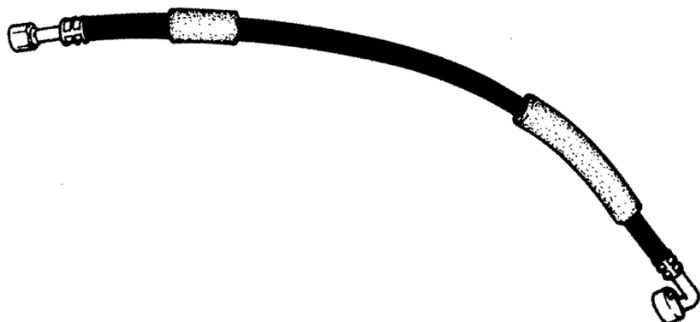

HO7603

Galant HG, HH
Suction

6/90 - 11/92



HO7475

Lancer CC
Suction 1.5Lt, R134a



HO7476

Lancer CC
Discharge 1.5Lt, R134a



HO7465

Lancer CA, CB
Suction



AL5512

Magna TH
Suction



Direct Replacement

Mitsubishi

AL5510

Magna TH
Suction



AL5511

Magna TH
Evaporator to FDR

Picture unavailable at time of print

HO8259

Magna TH
Discharge



HO8258

Magna TH
Suction



AL5513

Magna TE-TJ
CN-FDR Liquid pipe

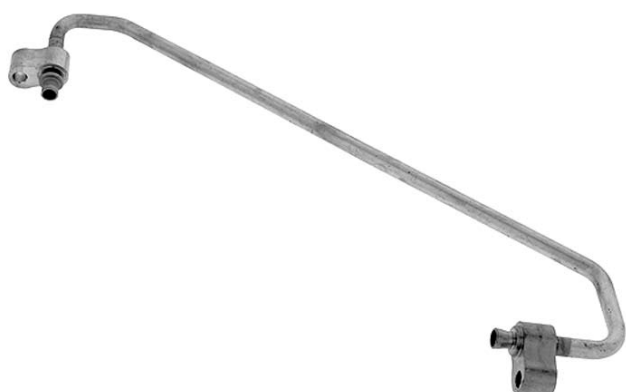

HO8247

Magna TR
Suction V6



Mitsubishi

Direct Replacement

HO8248

Magna TR
Discharge V6



HO8242

Magna TN, TP
Discharge
Genuine # AW 319583



HO8243

Magna TR
Auto/Carb, 4 cyl, Suction
AW 329536

4/91 - 3/93



HO8244

Magna TR
Auto/Carb, 4 cyl, Discharge
AW 329537

4/91 - 3/93



HO8245

Magna TR EFI
Suction



HO8246

Magna TR EFI
Discharge
Genuine # AW 328632



Direct Replacement

Nissan

HO6542

Pulsar
Discharge
Genuine # 92490-J7511

89



HO8303K

Pulsar 2.0Lt
Hose Assembly suits Zexel compressor only



AL5174

Pulsar N15
Pipe Set
To suit CN5174



HO6484

Pulsar N13
Suction
Genuine # 92490-J7510



HO6541

Pulsar N13
Suction
Genuine # 92480-J7501

89



HO8255

Pulsar N15 1.6Lt
Discharge R134a

Picture unavailable at time of print

Hose & Pipe

Toyota

Direct Replacement

HO0116

Camry SV21

Discharge

Genuine # 246120-1990



HO0117

Camry SV21

Suction

Genuine # 246140-3520



HA0272

Corolla AE101R

Suction

Picture unavailable at time of print

HO0120

Corolla AE90, 92

Discharge R12

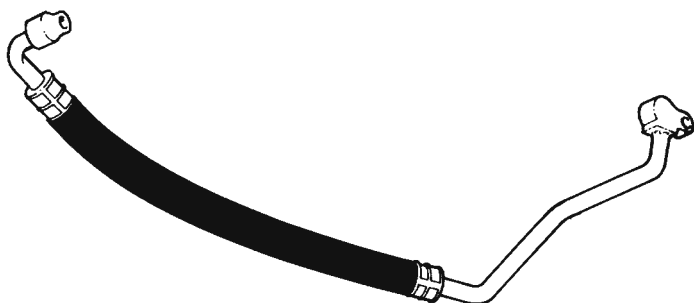

HO0129

Corolla AE90, 92 1.4, 1.6, 1.8Lt

Discharge R134a



HO0128

Corolla AE90, 92 1.4, 1.6, 1.8Lt

Suction R134a



Direct Replacement

Toyota

Toyota Corolla ZZE122R (Sedan)

- 1. HO8001
- 2. HO8002
- 3. AL8003
- 4. AL8000
- 5. AL8006
- 6. AL8007

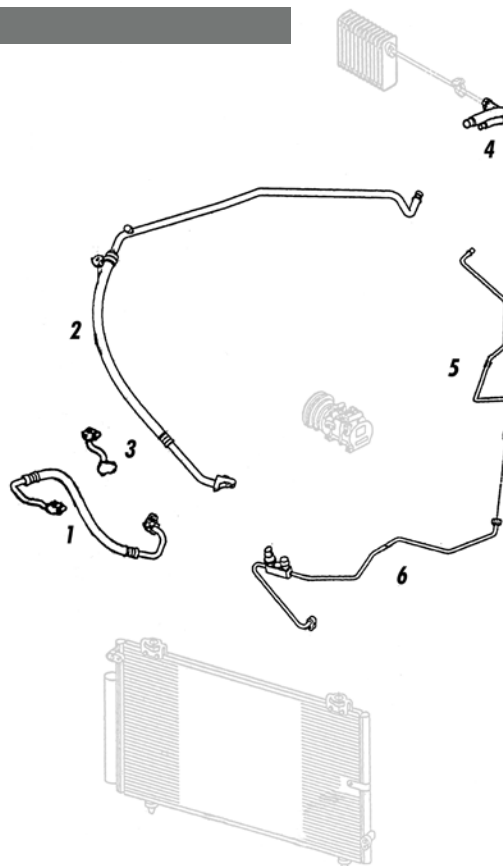

Toyota Corolla ZZE122R (Hatch)

- 1. HO8001
- 2. HO8003
- 3. AL8003
- 4. AL8000
- 5. AL8004
- 6. AL8005

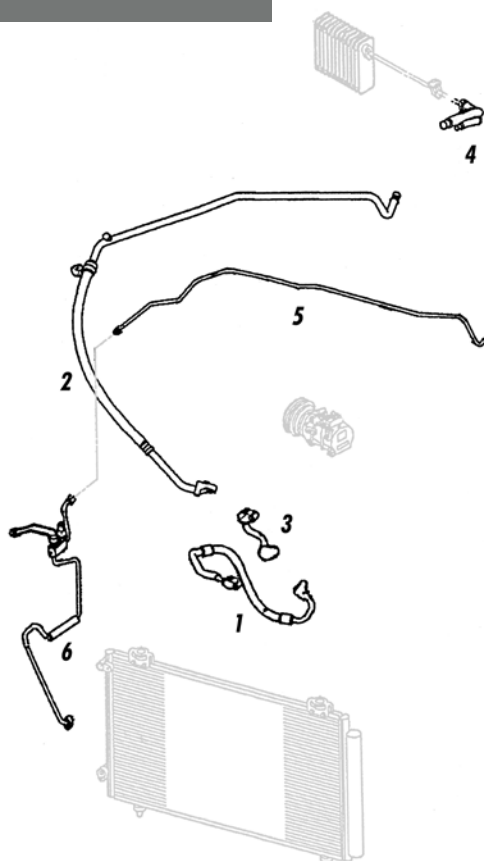

Hose & Pipe

Toyota

Direct Replacement

HO0149

Hilux 2.7Lt 4 cyl TGN Chassis
Discharge

05>



HO0158

Hilux 3.0Lt Turbo KUN Chassis
Discharge

05>



HO0157

Hilux V6 4.0Lt GGN Chassis
Discharge

05>



AL0525

Landcruiser HJ75, HZJ75
FDR-Evap, Cooltemp system

Picture unavailable at time of print

AL0280

Landcruiser HJ75, HZJ75 "A"
Suction, Cooltemp system

Picture unavailable at time of print

AL0526

Landcruiser HJ75, HZJ75 "B"
Suction, Cooltemp system

Picture unavailable at time of print

Direct Replacement

Toyota

Toyota Landcruiser HZJ80 & HDJ80

R134a

1. HO0152
2. HO0153 HZJ80
HO0154 HDJ80
3. AL2008
4. AL2009
5. AL2011
6. AL2006
7. AL2010

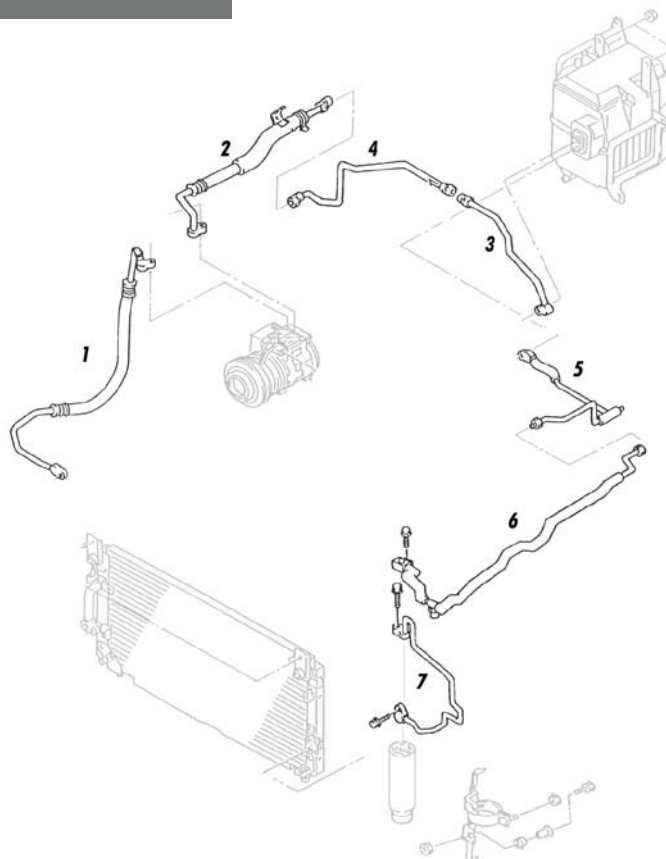

Toyota Landcruiser FZJ80

R134a

1. HO0150
2. HO0151
3. AL2008
4. AL2009
5. AL2007
6. AL2006
7. AL2010

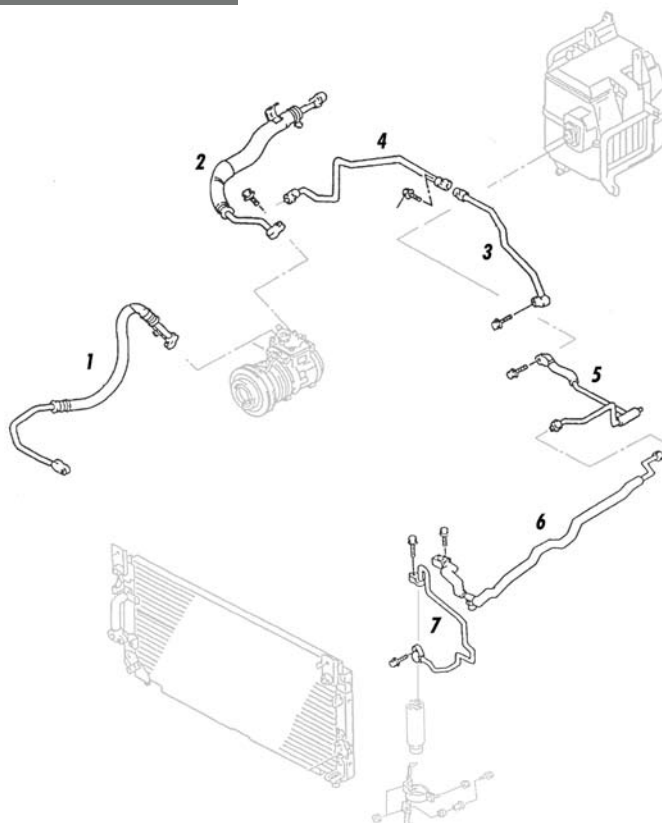

Toyota

Direct Replacement

AL0282

Landcruiser HJ75, HZJ75 "C"
Suction, Cooltemp system

Picture unavailable at time of print

AL2006

Landcruiser FZJ80, HZJ80 & HDJ80
Liquid Pipe with sight glass

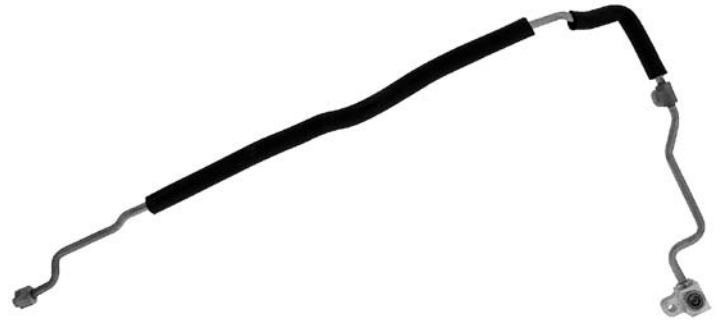

AL2007

Landcruiser FZJ80



AL2008

Landcruiser FZJ80, HZJ80 & HDJ80



AL2009

Landcruiser FZJ80, HZJ80 & HDJ80



AL2010

Landcruiser FZJ80, HZJ80 & HDJ80

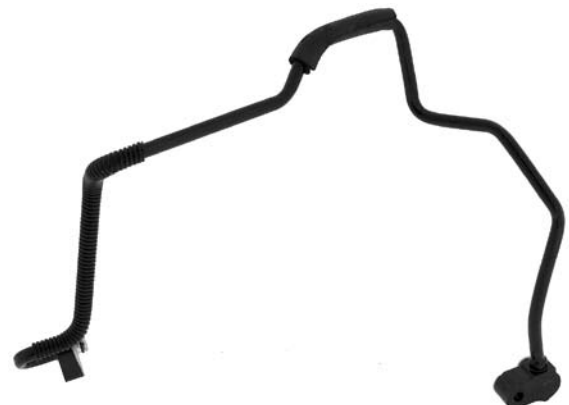

Direct Replacement

Toyota

HO0150

Landcruiser FZJ80



HO0151

Landcruiser FZJ80



AL2011

Landcruiser HZJ80 & HDJ80

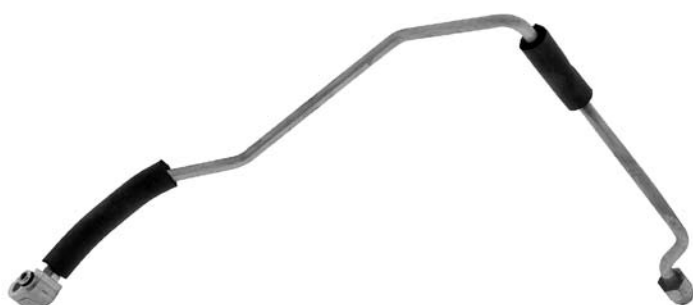

HO0152

Landcruiser HZJ80 & HDJ80



HO0153

Landcruiser HZJ80 & HDJ80



HO0154

Landcruiser HZJ80 & HDJ80



Hose & Pipe

Toyota

Direct Replacement

HO0159

Prado GRJ Petrol
Discharge



HO0160

Prado KZJ Diesel
Discharge



HO4090

Rav4
Discharge

3/94 - 00



AL0300

Rav4
Cond-FDR Liquid pipe



HO4800

Starlet
Discharge

